

GRUPO **AUTOMOTIVE**
PARTES ELECTRICAS, S.A. DE C.V.

SOPORTES
SOPORTES
SOPORTES

www.automotive.com.mx

PRECIOS SUJETOS A CAMBIOS SIN PREVIO AVISO
NO VÁLIDA PARA OTRAS PROMOCIONES

BUJES



GRUPO **AUTOMOTIVE**
PARTES ELECTRICAS, S.A. DE C.V.



B15297

\$
66.15

BUJE BARRA TRASERO CHICO
VOLKSWAGEN GOLF VII 1.4L
TSI 15-19, SEAT LEON 2.0L
14-20, ATECA 1.4L TSI 17-19,
AUDI A3 1.4L T 13-20.
(ACOPLAMIENTO).

#PARTE: 5Q0501529C

B98681

\$
84.00

BUJE EJE DELANTERO
SUPERIOR VOLKSWAGEN BORA
2.5L FSI 05-10, GTI 2.0L T 05-09,
SEAT LEON 1.4L TSI 07-13, ALTEA
1.8L TSI 07-14, AUDI A3 1.4L T
04-12. TRANSMISION MANUAL 5
VELOCIDADES. (BUJE PORTAGRUPO)

#PARTE: 1K0199868A

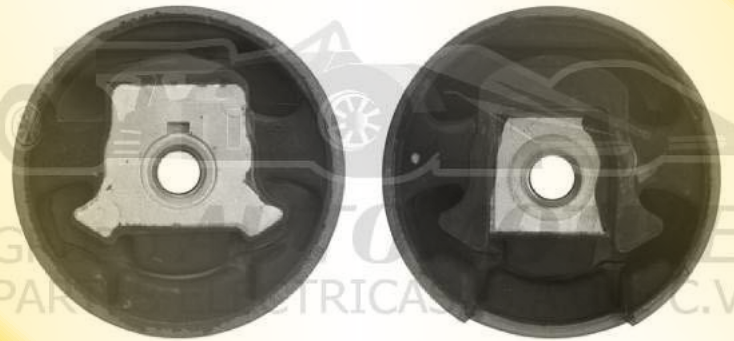

B47183

\$
137.55

BUJE HORQUILLA AUDI A4 1.8L
94-00. INFERIOR.



#PARTE: 4D0407183P

BUJES



GRUPO **AUTOMOTIVE**
PARTES ELECTRICAS, S.A. DE C.V.

B86389

\$
57.75

BUJE HORQUILLA CHEVROLET
ASTRA 1.8L 00-05. TRASERO.



#PARTE: 90468638

B45976

\$
33.60

BUJE HORQUILLA CHEVROLET
CHEVY 1.6L 1995-2012.

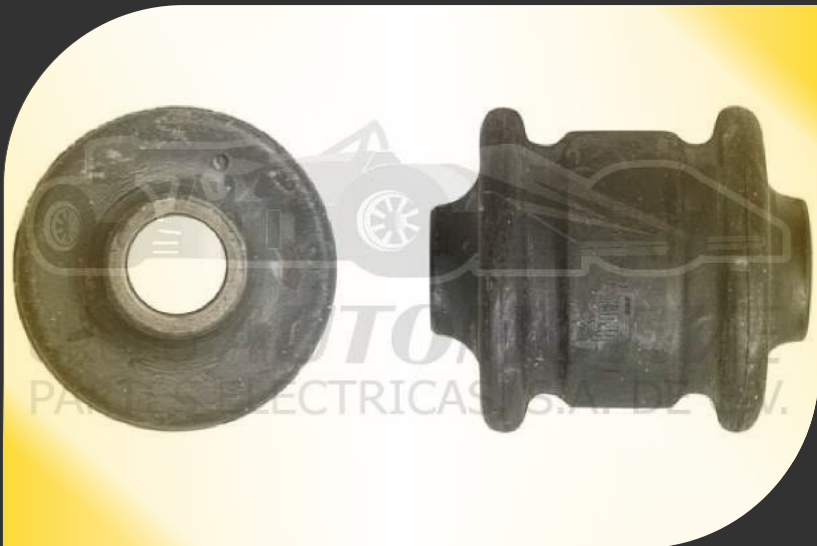

#PARTE: 90445097

B64613

\$
47.25

BUJE HORQUILLA NISSAN
SENTRA 4CIL 1.6L 87-90,
TSURU II 4CIL 1.6L 88-91.
INFERIOR GRANDE (PUNTA)
(GOMA).
64610



#PARTE: 54570-50A10

GRUPO **AUTOMOTIVE**
PARTES EL... DE C.V.

BUJES BUJES BUJES



GRUPO **AUTOMOTIVE**
PARTES ELECTRICAS, S.A. DE C.V.



B57548

\$
53.55

BUJE HORQUILLA NISSAN
SENTRA 91-95, TSUBAME
93-04, TSURU III 92-16.
GRANDE (PUNTA).
64660

#PARTE: 54570-50Y11

B54565

\$
43.05

BUJE HORQUILLA NISSAN
TSURU III 4CIL 1.6L 92-17,
TSURU II 1.6L 88-91, SENTRA
B14 1.6L 95-99, TSUBAME 1.6L
94-00, LUCINO 1.6L 95-00.
INFERIOR CHICO (METAL)

#PARTE: 54560-50A00



B99233

\$
192.15

BUJE HORQUILLA VOLKSWAGEN
BORA 2.5 FSI 05-10, GTI 2.0L T
05-09, TIGUAN 2.0L TSI 08-17,
SEAT LEON 1.4L TSI 07-13,
ALTEA 1.8L TSI 07-14, TOLEDO
2.0L TSI 06-09. (PUNTA DE
ALUMINIO GRANDE). DERECHO.

#PARTE: 1K0199232G



BUJES BUJES BUJES



GRUPO **AUTOMOTIVE**
PARTES ELECTRICAS, S.A. DE C.V.

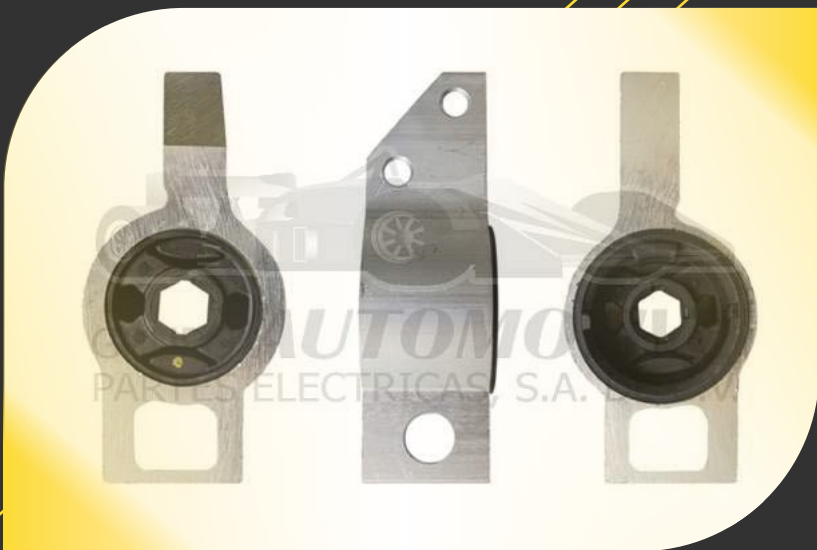

B23993

BUJE HORQUILLA
VOLKSWAGEN BORA 2.5 FSI
05-10, GTI 2.0L T 05-09, TIGUAN
2.0L TSI 08-17, SEAT LEON 1.4L
TSI 07-13, ALTEA 1.8L TSI 07-14,
TOLEDO 2.0L TSI 06-09. (PUNTA
DE ALUMINIO GRANDE).
IZQUIERDO.

\$
192.15

#PARTE: 1K0199231G

B70874

BUJE HORQUILLA
VOLKSWAGEN EUROVAN T4
1.9L TDI 01-04. TRASERO
SUPERIOR.

\$
30.45

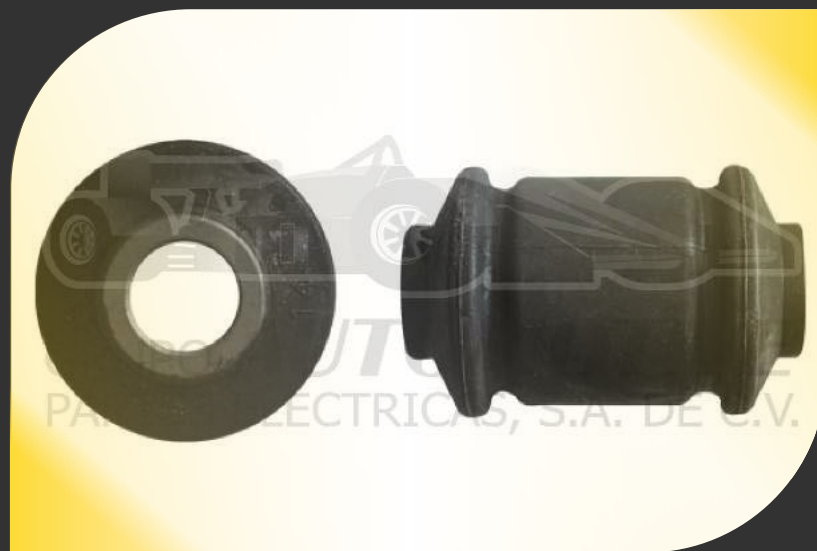

#PARTE: 701407087

BUJES BUJES BUJES



GRUPO **AUTOMOTIVE**
PARTES ELECTRICAS, S.A. DE C.V.



B38171

\$
66.15

BUJE HORQUILLA
VOLKSWAGEN JETTA VII 1.4L
TSI 19-20, JETTA VI 2.5L 11-18,
NEW BEETLE 2.5L 11-19, PASSAT
2.5L 12-18, GOLF VII 1.4L TSI
15-19, TIGUAN II 1.4L TSI 18-19,
SEAT LEON 1.4L TSI 14-20, AUDI
A3 1.4L T 13-20. GRANDE.

#PARTE: 5Q0407183E

B71822

\$
49.35

BUJE HORQUILLA VOLKSWAGEN
POLO 1.6L 03-07, LUPO 1.6L
05-09, CROSSFOX 1.6L 06-17,
SPORTVAN 1.6L 06-10, GOLF VII
1.4L TSI 15-19, SEAT IBIZA 1.6L
03-08, CORDOBA 1.6L 03-09,
LEON 1.4L T 14-20. CHICO
BARRIL.

#PARTE: 5Q0407182A

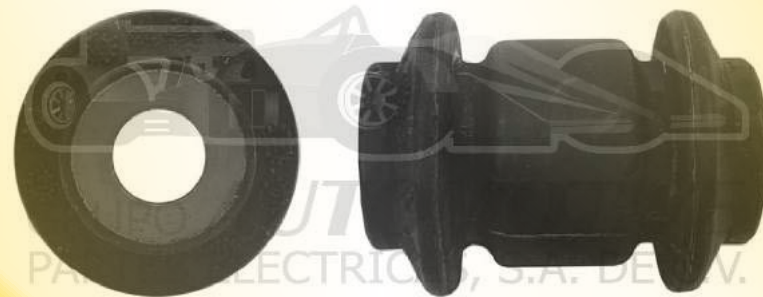

SOPORTES SOPORTES SOPORTES



GRUPO **AUTOMOTIVE**
PARTES ELECTRICAS, S.A. DE C.V.

363130

\$

387.45

SOPORTE BASE
AMORTIGUADOR BMW 1 10-19,
BMW 3 11-18. DELANTERO.
31 30 6 880 438 S1



#PARTE: 31306863135S1

347345

\$

268.80

SOPORTE BASE AMORTIGUADOR
BMW 118i 11-15 / 15-19, 120i
15-16, 220i 13-21, 240i 15-21, 318i
15-18, 320i 15-18, 328i 11-18, 330i
15-18, 335i 11-15, 340i 15-18, 420i
13-17, 428i 13-17, 430i
16-20. 31306863135, 3130685507,
31306855817. DELANTERO.
31306791701

#PARTE: 10300447

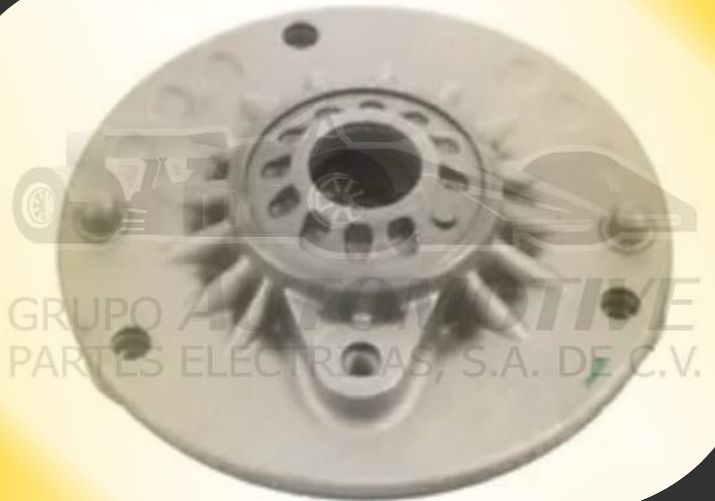

312345

\$

217.35

SOPORTE BASE AMORTIGUADOR
BMW 5 95-03, BMW 5 96-04, BMW
3 SEDAN 98-05, BMW 3 COUPÉ
99-06, BMW 5 SEDAN 01-10, BMW
5 TOURING 04-10. 31306775098,
31306767451, 31336760943,
31336769582. DELANTERO.
31336752735



#PARTE: 10300412

SOPORTES SOPORTES SOPORTES



GRUPO **AUTOMOTIVE**
PARTES ELECTRICAS, S.A. DE C.V.

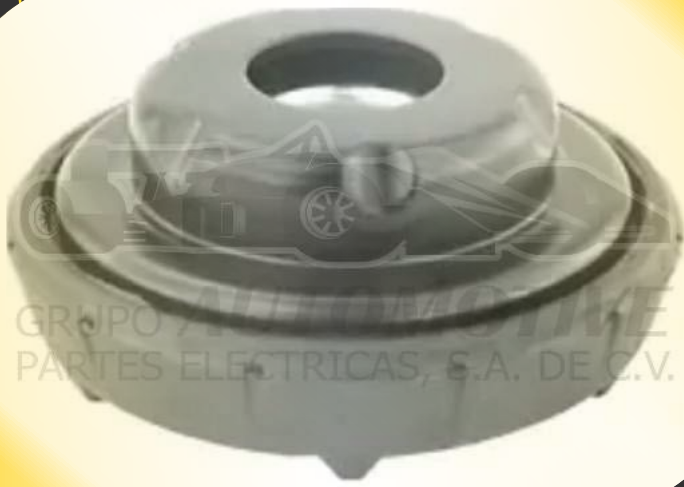

364685

\$
163.80

SOPORTE BASE AMORTIGUADOR BUICK VERANO 4CIL 2.0L 13-17, VERANO 4CIL 2.4L 12-17, CHEVROLET CRUZE 4CIL 1.4L 11-16, CRUZE 4CIL 1.8L 11-16, CRUZE 4CIL 2.0L DIESEL 14-15, TRAX 4CIL 1.4L 13-22, VOLT 4CIL 1.4L 11-15, VOLT 4CIL 1.4L HIBRIDO 11-15, VOLT ELECTRICO 11-15. 22809842 13505131, 7385. DELANTERO IZQUIERDO. 95212727

#PARTE: 10600468

331640

\$
107.10

SOPORTE BASE AMORTIGUADOR CHEVROLET AVEO 1.6L 08-18, PONTIAC G3 1.6L 06-10. TRASERO. 96456713 S2

#PARTE: 10300164



516287

\$
192.15

SOPORTE BASE AMORTIGUADOR CHEVROLET BEAT 1.2L 18-20, SPARK 1.2L / 1.4L 11-20, SONIC 1.6L 12-17. CON PLATO Y BALERO INCLUIDO. DELANTERO.

#PARTE: 95227628



SOPORTES SOPORTES SOPORTES



GRUPO **AUTOMOTIVE**
PARTES ELECTRICAS, S.A. DE C.V.

368252

\$
70.35



SOPORTE BASE
AMORTIGUADOR CHEVROLET
CHEVY 1996-2012. IZQUIERDO
/ DERECHO (SWING, POP,
MONZA, JOY). DELANTERO.
344519

#PARTE: 10600825

336337

\$
203.70

SOPORTE BASE
AMORTIGUADOR CHEVROLET CORSA
1.8L 02-09, ASTRA 1.8L 00-05, ZAFIRA
1.8L 00-05, ZAFIRA 2.2L 05-06, MERIVA
1.8L 06-08, TORNADO 1.8L
03-19. (ACERO). DELANTERO.
90468618
90468554
90216299

#PARTE: 80300633



383057

\$
135.45



SOPORTE BASE AMORTIGUADOR DODGE
AVENGER 07-14, CALIBER 07-12, VAN
12-15, SEBRING 07-11, CHRYSLER
PACIFICA 17-20, TOWN & COUNTRY
08-14, JEEP COMPASS 07-17, PATRIOT
07-17, VOLKSWAGEN ROUTAN 09-15.
7332, 5171122AC. DELANTERO
IZQUIERDO / DERECHO.
5085461AB
5085458AA

#PARTE: 80300005

SOPORTES SOPORTES SOPORTES



GRUPO **AUTOMOTIVE**
PARTES ELECTRICAS, S.A. DE C.V.



534998

\$
297.15

SOPORTE BASE AMORTIGUADOR DODGE
CARAVAN 4CIL 2.4L 01-07, CARAVAN 6CIL
3.3L 01-07, GRAND CARAVAN 6CIL 3.3L 01-07,
GRAND CARAVAN 6CIL 3.8L 04-07, CHRYSLER
PACIFICA 6CIL 3.5L 04-06, PACIFICA 6CIL 3.8L
05-08, PACIFICA 6CIL 4.0L 07-08, TOWN &
COUNTRY 6CIL 3.3L / 3.8L 01-07, VOYAGER 4CIL
2.4L 01-03, VOYAGER 6CIL 3.3L 01-03. 7051,
4862027AB. DELANTERO IZQUIERDO /
DERECHO.
4766116AA
4766116AB

#PARTE: 80300499

536311

\$
160.65

SOPORTE BASE AMORTIGUADOR
FORD C-MAX 13-17, ESCAPE 13-18,
FOCUS 07-17, LINCOLN MKC 15-17,
MAZDA 3 04-13, MERCURY MARI-
NER 13-17, VOLVO C30 07-10, C70
08-13, S40 04-11, V50 05-11. 7182.
DELANTERO IZQUIERDO / DERECHO.
CV6Z-3A197-D
DV6Z-18198-B

#PARTE: 80300631



512421

\$
95.55

SOPORTE BASE AMORTIGUADOR
FORD ECOSPORT 18-21, FIESTA
12-19, FIGO 15-20, MAZDA 2 4CIL
1.5L 11-16. 8241. TRASERO
IZQUIERDO / DERECHO.
8V51-18A116-AA

#PARTE: 10300242

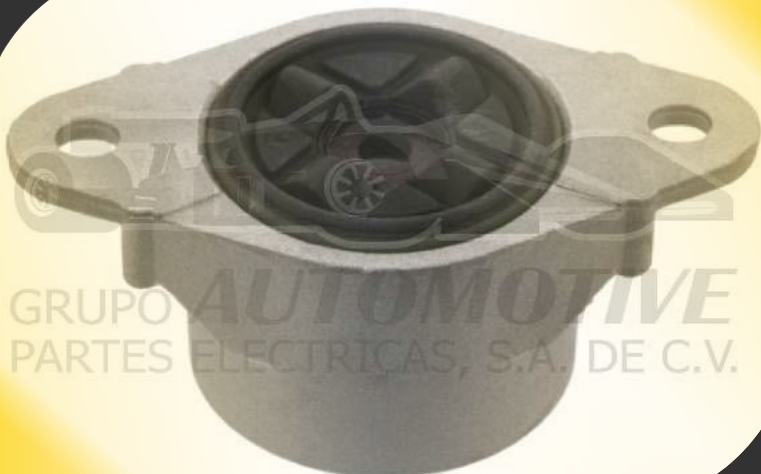

GRUPO **AUTOMOTIVE**
PARTES ELECTRICAS, S.A. DE C.V.

SOPORTES SOPORTES SOPORTES



GRUPO **AUTOMOTIVE**
PARTES ELECTRICAS, S.A. DE C.V.

336249

\$
227.85

SOPORTE BASE AMORTIGUADOR
FORD F-150 4.2L / 4.6L 04-08,
LINCOLN MARK LT 4.2L / 4.6L
04-06.

7L3Z-18A099-A
4L3Z-5415-AA

#PARTE: 80300624

346326

\$
99.75

SOPORTE BASE
AMORTIGUADOR FORD FIESTA
01-10, FUSION 02-12, MAZDA
323 80-89, MAZDA 2 03-07.
1697347, 1253168, 1469224,
2S613K155AE, DD3234380A.
DELANTERO.
1146153

#PARTE: 10300246



362650

\$
105.00

SOPORTE BASE
AMORTIGUADOR FORD FOCUS
05-06. DELANTERO IZQUIERDO.
3M513K155DC

#PARTE: 10600265



SOPORTES SOPORTES SOPORTES



GRUPO **AUTOMOTIVE**
PARTES ELECTRICAS, S.A. DE C.V.

343327

\$
99.75

SOPORTE BASE
AMORTIGUADOR FORD
FOCUS 98-07, TRANSIT
2002=>. 98AG3K155AF.
DELANTERO IZQUIERDO.
1087177

#PARTE: 10300243

387354

\$
70.35

SOPORTE BASE
AMORTIGUADOR FORD KA
1.3L 96-08, COURIER, FIESTA.
1101042, 96FB18198A2G,
802060. TRASERO.
1023587

#PARTE: 10300587

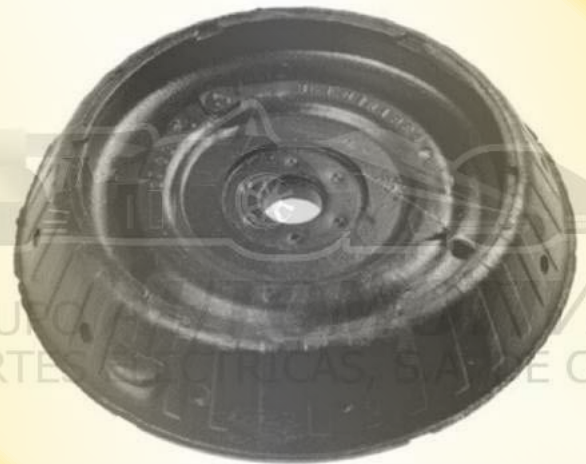

339323

\$
139.65

SOPORTE BASE
AMORTIGUADOR FORD KA
4CIL 1.6L 2005. DELANTERO.
1013794
1055193

#PARTE: 80300239



SOPORTES SOPORTES SOPORTES



GRUPO **AUTOMOTIVE**
PARTES ELECTRICAS, S.A. DE C.V.

331299

\$
105.00

SOPORTE BASE AMORTIGUADOR HONDA, ACURA EL 2001, RSX 02-06, HONDA CIVIC 02-05, CR-V 02-06, ELEMENT 03-11. 51726S5A004, 8652. DELANTERO.
51925S7A024
51726S5A002

#PARTE: 10300129

360641

\$
213.15

SOPORTE BASE AMORTIGUADOR HONDA, ACURA RDX 4CIL 2.3L 08-12, HONDA CR-V 4CIL 2.4L 07-16. 51726-STK-A01, 7572. DELANTERO IZQUIERDO.
51920SWAA01
51726SWAA01

#PARTE: 80600064



336308

\$
14.70

SOPORTE BASE AMORTIGUADOR HONDA. GOMA TRASERO. 51631-SB0-004

#PARTE: 10300630



SOPORTES SOPORTES SOPORTES



GRUPO **AUTOMOTIVE**
PARTES ELECTRICAS, S.A. DE C.V.

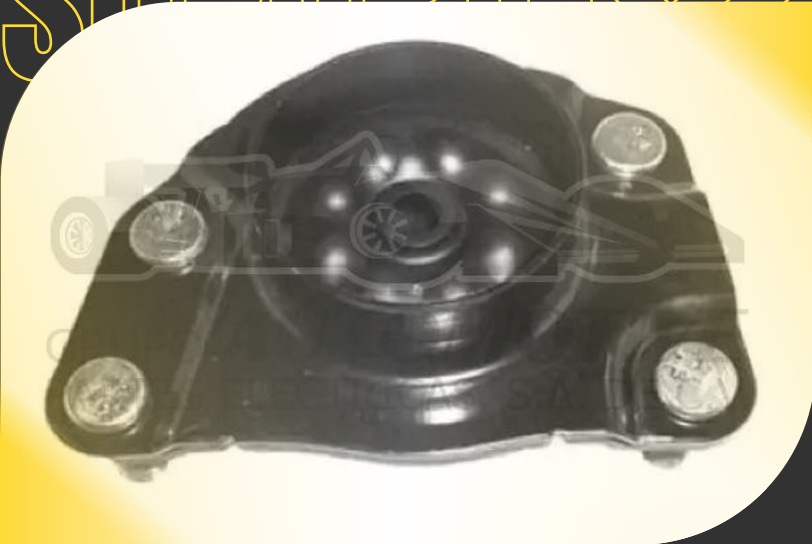

536265

\$
193.20

SOPORTE BASE
AMORTIGUADOR JEEP LIBER-
TY 02-07. 7370. DELANTERO
IZQUIERDO.
52128533AA

#PARTE: 10300626

536278

\$
193.20

SOPORTE BASE
AMORTIGUADOR JEEP
LIBERTY 02-07. 7371.
DELANTERO DERECHO.
52128532AA

#PARTE: 10300627



517062

\$
184.80

SOPORTE BASE
AMORTIGUADOR MINI COOPER
2013-2018. TRASERO.

#PARTE: 33506791706



GRUPO **AUTOMOTIVE**
PARTES ELECTRICAS, S.A. DE C.V.

SOPORTES SOPORTES SOPORTES



GRUPO **AUTOMOTIVE**
PARTES ELECTRICAS, S.A. DE C.V.

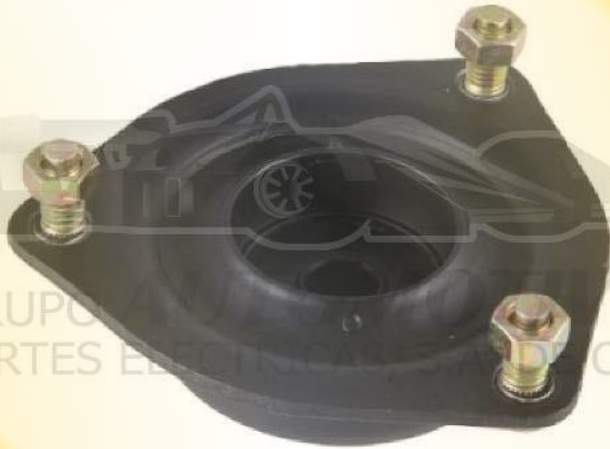

536294

**\$
85.05**

SOPORTE BASE
AMORTIGUADOR NISSAN
ALMERA 01-05, SENTRA 00-06.
7026. DELANTERO IZQUIERDO
/ DERECHO.
54320-BM400
54320-4Z020

#PARTE: 10300629

513319

**\$
154.35**

SOPORTE BASE
AMORTIGUADOR NISSAN
ALMERA 01-06, SENTRA 01-06,
RENAULT SCALA 10-13.
DELANTERO.
55320-4M401
55320-4Z001

#PARTE: 10300311

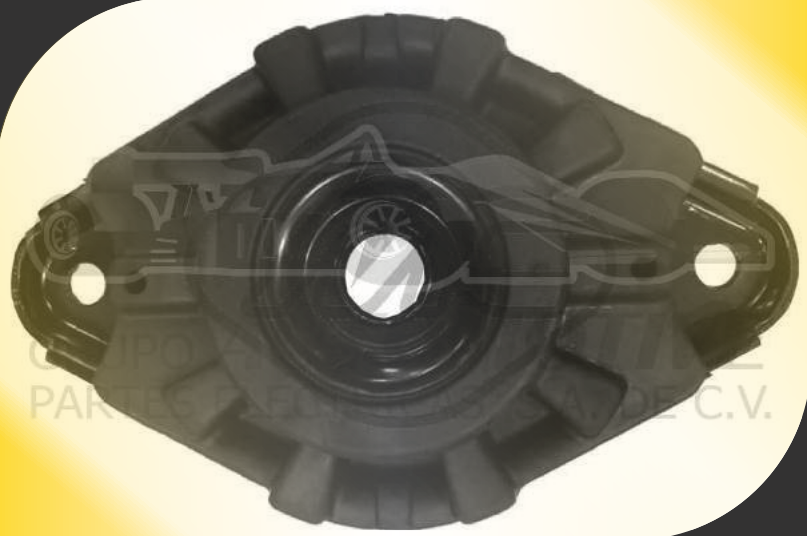

536223

**\$
134.40**

SOPORTE BASE AMORTIGUADOR
NISSAN APRIO 07-11, RENAULT
DUSTER 11-18, LOGAN 4CIL 1.6L
07-19, OROCH 18-19, SANDERO
10-20, STEPWAY 10-18. 7443.
DELANTERO IZQUIERDO.
8200723741
8200651172
8200876298

#PARTE: 80300622



SOPORTES SOPORTES SOPORTES



GRUPO **AUTOMOTIVE**
PARTES ELECTRICAS, S.A. DE C.V.

365326

\$
196.35



SOPORTE BASE
AMORTIGUADOR NISSAN JUKE
11-18, MICRA 05-08, TIIDA
4CIL 1.8L 06-18, VERSA 09-11.
7394. DELANTERO IZQUIERDO.
54321-AZ60B
54325-ED00A

#PARTE: 80600532

374266

\$
65.10

SOPORTE BASE
AMORTIGUADOR NISSAN
PLATINA 02-10, RENAULT
CLIO 02-10, KANGOO 04-17.
5431000QAA, 7017.
DELANTERO IZQUIERDO /
DERECHO.
7700829529

#PARTE: 10101426



383349

\$
96.60



SOPORTE BASE
AMORTIGUADOR NISSAN
VERSA 1.6L 11-19, MARCH
1.6L 11-19, NOTE 1.6L 13-19.
SIN BALERO. DELANTERO.
54320-1HJ0A
54325-1HA0A
54342-1HJ0B

#PARTE: 80300034

SOPORTES SOPORTES SOPORTES



GRUPO **AUTOMOTIVE**
PARTES ELECTRICAS, S.A. DE C.V.



583323

\$
228.90

SOPORTE BASE
AMORTIGUADOR NISSAN
X-TRAIL 4CIL 2.5L 08-13,
RENAULT KOLEOS 4CIL 2.5L
08-16. 7411. DELANTERO
DERECHO.
54320-JG01B
54325-ED02A

#PARTE: 80300327

536281

\$
130.20

SOPORTE BASE
AMORTIGUADOR TOYOTA
COROLLA 4CIL 1.8L 03-08,
MATRIX 4CIL 1.8L 03-08,
PONTIAC 09-10. 7320 (CHICA).
DELANTERO IZQUIERDO /
DERECHO.
48609-02190

#PARTE: 10300628



568193

\$
115.50

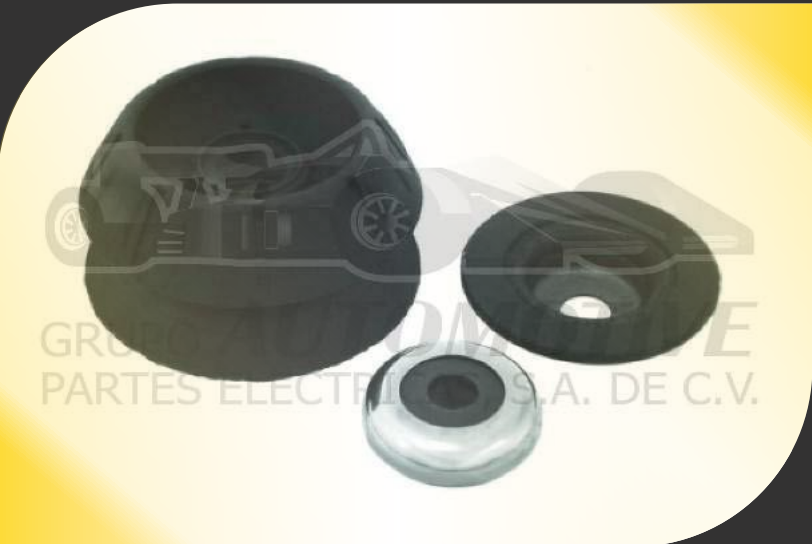

SOPORTE BASE AMORTIGUADOR
TOYOTA PRIUS ELECTRICO 12-19,
PRIUS 4CIL 1.5L 12-19, PRIUS 4CIL
1.5L HIBRIDO 12-19, YARIS 4CIL 1.5L
07-18. 48609-0D041. DELANTERO
IZQUIERDO.
48609-52100
48619-0D011
48682-52040

#PARTE: 80600819

SOPORTES SOPORTES SOPORTES



GRUPO **AUTOMOTIVE**
PARTES ELECTRICAS, S.A. DE C.V.

329233

\$
164.85



SOPORTE BASE
AMORTIGUADOR
VOLKSWAGEN ATLANTIC 1.7L
/ 1.8L 81-87, CARIBE 1.6L /
1.8L 77-87. CON BALERO.
DELANTERO.

#PARTE: 171412329A

331695

\$
169.05

SOPORTE BASE
AMORTIGUADOR
VOLKSWAGEN CRAFTER 2.0L /
2.5L TDI 07-16, CRAFTER 2.0L
TDI 17-20, SPRINTER 2.1L
DIESEL 11-19.
2E0407181C

#PARTE: 10300169



362575

\$
114.45



SOPORTE BASE
AMORTIGUADOR
VOLKSWAGEN CROSSFOX 1.6L
06-17, POLO 1.6L 03-07, LUPO
1.6L 05-09. DELANTERO.
6Q0 412 331B

#PARTE: 10600257

SOPORTES SOPORTES SOPORTES



GRUPO **AUTOMOTIVE**
PARTES ELECTRICAS, S.A. DE C.V.

536252

\$
40.95



SOPORTE BASE
AMORTIGUADOR VOLKSWAGEN
GOL 08-11, GOLF 12-17,
POINTER GTI / CITY/ STATION
WAGON / PICK UP 1.6L / 1.8L /
2.0L 94-10. TRASERO INFERIOR.
321 512 333
321 512 335

#PARTE: 80300625

523472

\$
148.05

SOPORTE BASE
AMORTIGUADOR VOLKSWAGEN
GOLF VII 1.4L TSI 15-19, TIGUAN
1.4L TSI 18-19, AUDI A3 1.8L T
13-20, Q2 1.4L TSI 16-20, TT 2.0L
TFSI 15-19. SIN BALERO.
DELANTERO.

#PARTE: 5Q0412331E

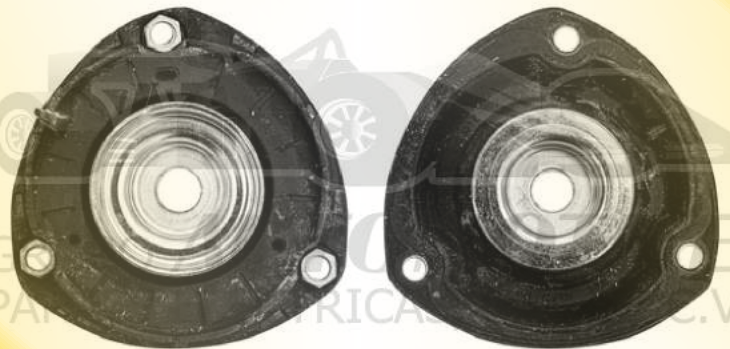

562499

\$
189.00



SOPORTE BASE AMORTIGUADOR
VOLKSWAGEN JETTA 2.5L 11-18,
BORA 2.5L FSI 05-10, NEW
BEETLE 2.5L 11-19, GOLF 1.4L TSI
15-19, PASSAT 2.0L T 05-11,
PASSAT 2.5L, 3.6L 12-18, GTI 2.0L
T 05-09. SIN BALERO.
DELANTERO.
1K0 412 331BS1

#PARTE: 80600249

SOPORTES SOPORTES SOPORTES



GRUPO **AUTOMOTIVE**
PARTES ELECTRICAS, S.A. DE C.V.

312374

\$
66.15

SOPORTE BASE
AMORTIGUADOR
VOLKSWAGEN PASSAT 1.8L T
98-04, AUDI A4 1.8L T 94-00.
SIN BALERO. DELANTERO.

#PARTE: 4D0412377F

364031

\$
95.55

SOPORTE BASE
AMORTIGUADOR
VOLKSWAGEN POINTER 4CIL
1.8L 00-06. DELANTERO.
5X0412329

#PARTE: 10600403



362882

\$
85.05

SOPORTE BASE AMORTIGUADOR
VOLKSWAGEN, AUDI A1 11-17, SEAT
CORDOBA 03-08, IBIZA 4CIL 2.0L
03-18, LEON 01-05, TOLEDO 01-05 / 13-18,
VOLKSWAGEN JETTA 2.0L 99-15, GOLF
2.0L 99-07, BEETLE 2.0L 98-11, POLO 1.6L
03-07, CROSSFOX 4CIL 1.6L 06-17, LUPO
1.6L 05-09, SPORTVAN 1.6L 06-10,
PASSAT 1.8L T 98-04. 1J0-513-353-B.
TRASERO.
1J0 513 353D

#PARTE: 10600288



SOPORTES SOPORTES SOPORTES



GRUPO **AUTOMOTIVE**
PARTES ELECTRICAS, S.A. DE C.V.

333531

\$
124.95

SOPORTE BASE AMORTIGUADOR
VOLKSWAGEN, AUDI A1 11-18, A3 06-14, A3
Quattro 06-13, Q3 13-18, Q3 Quattro 13-18,
TT 08-14, TT Quattro 09-15, SEAT ALTEA
05-15, LEON 05-13, TOLEDO 05-06,
VOLKSWAGEN BORA 05-10, EOS 07-17,
GOLF 10-15, GTI 06-14, JETTA 11-16,
PASSAT 12-19, PASSAT CC 09-19, TIGUAN
08-17. 3C0-513-353-E, 1K0-5133-533-J.
TRASERO.
8297

#PARTE: 3C0513353C

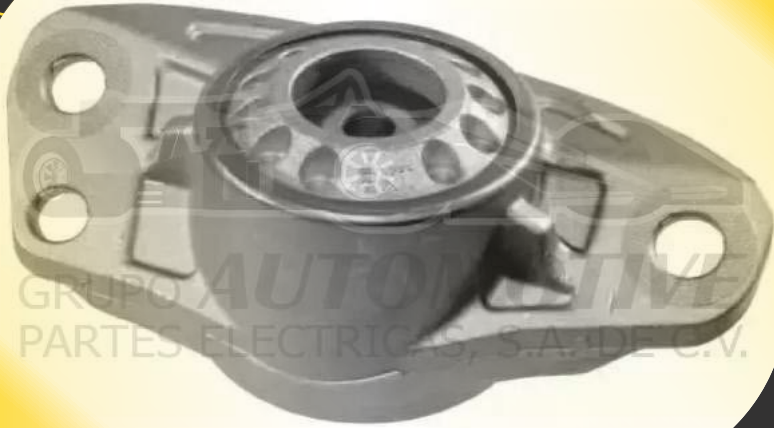

352633

\$
123.90

SOPORTE BASE AMORTIGUADOR
VOLKSWAGEN, AUDI A3 00-09, SEAT
ALTEA 05-15, LEON 13-15, TOLEDO
05-06, VOLKSWAGEN BEETLE 12-19,
BORA 05-10, EOS 08-16, GOLF 06-14,
JETTA 07-18. 1K0-513-353-J,
1Q0-513-353, 8122. TRASERO
IZQUIERDO.
1K0 513 353G

#PARTE: 10600352



364188

\$
143.85

SOPORTE BASE AMORTIGUADOR
VOLKSWAGEN, AUDI A3 15-20, A3
Quattro 15-19, Q3 19-20, RS3 17-19,
S3 15-19, TT Quattro 16-20, SEAT
ARONA 17-21, ATECA 16-21, IBIZA
18-23, LEON 14-19, TARRACO 19-21,
VOLKSWAGEN GOLF 15-20, JETTA
16-20, TAOS 2021, TIGUAN 18-20,
VIRTUS 4CIL 1.6L 20-24. TRASERO.
5Q0 513 353H

#PARTE: 10600418



SOPORTES SOPORTES SOPORTES



GRUPO **AUTOMOTIVE**
PARTES ELECTRICAS, S.A. DE C.V.

383175



SOPORTE BASE AMORTIGUADOR
VOLKSWAGEN, SEAT ALHAMBRA 4CIL 1.8L
02-07, ALHAMBRA 6CIL 2.8L 01-10,
CORDOBA 4CIL 1.6L 01-02, IBIZA 4CIL 1.6L
01-02, VOLKSWAGEN GOLF A3 4CIL 1.8L
93-98, GOLF A3 4CIL 1.9L DIESEL 93-98, GOLF
A3 4CIL 2.0L 93-98, GOLF A3 6CIL 2.8L 95-98,
JETTA A3 4CIL 1.8L 93-98, JETTA A3 4CIL
1.9L DIESEL 93-97, JETTA A3 4CIL 2.0L 93-97,
JETTA A3 6CIL 2.8L 94-98, SHARAN 4CIL 1.8L
02-08. 6759. DELANTERO
IZQUIERDO.
357 412 331A S1

\$
86.10

#PARTE: 80300172

329322

SOPORTE BASE AMORTIGUADOR
VOLKSWAGEN, SEAT CORDOBA
93-02, TOLEDO 91-99, IBIZA
93-02, VOLKSWAGEN GOLF 93-98,
GOLF 83-92, POLO 95-06, POLO
97-01, JETTA 83-92, VENTO
91-98. CON BALERO. 191 412
329. DELANTERO.
176 412 329

\$
105.00

#PARTE: 10100012



336236

SOPORTE BASE DE AMORTI-
GUADOR NISSAN JUKE 11-18,
MICRA 1.4L 05-08, SENTRA
07-12, TIIDA 4CIL 1.8L 06-18,
RENAULT KOLEOS 08-16. 6149.
(SOLO BALERO).
54321-JG01B
54325-ED02A

\$
214.20

#PARTE: 80300623



SOPORTES SOPORTES SOPORTES



GRUPO **AUTOMOTIVE**
PARTES ELECTRICAS, S.A. DE C.V.

382856

\$
253.05

SOPORTE DE CAJA DE
VELOCIDADES CHEVROLET
ASTRA 2.0L/ 2.4L 00-05,
ZAFIRA 1.8L 00-05.

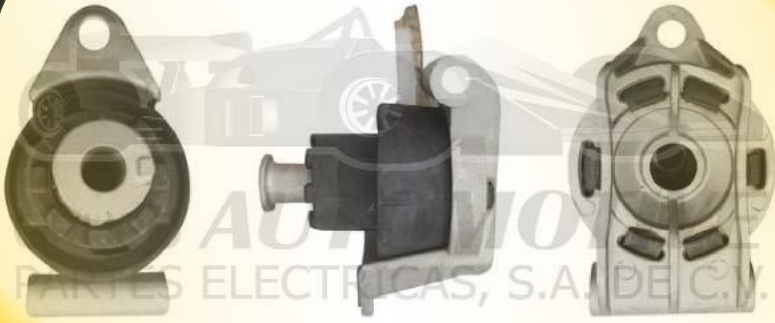

#PARTE: 90538582

322828

\$
301.35

SOPORTE DE CAJA DE
VELOCIDADES CHEVROLET
CORSA 1.8L 02-09, TORNADO
1.8L 03-09, MERIVA 1.8L
06-08. TRANSMISION
ESTANDAR (EASY TRONIC).
TRASERO.

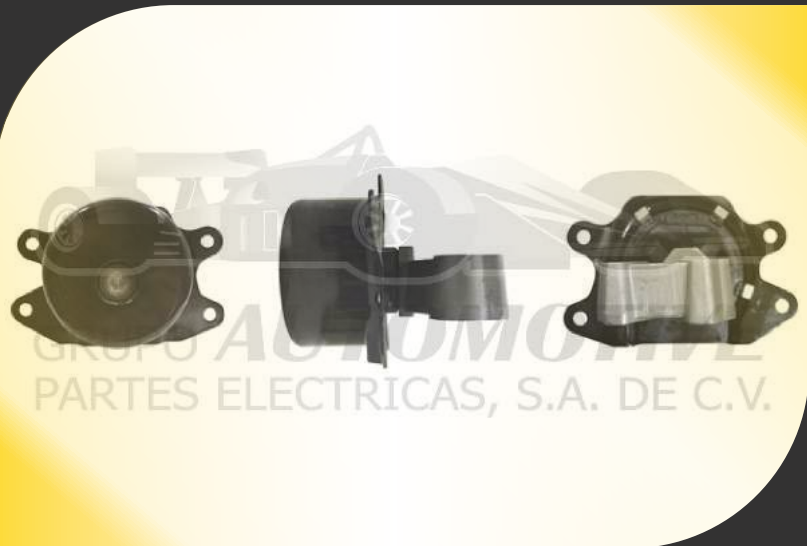

#PARTE: 93302282

369550

\$
357.00

SOPORTE DE CAJA DE
VELOCIDADES VOLKSWAGEN
VENTO 1.6L 14-19, POLO 1.6L
13-19, SEAT TOLEDO 1.6L
12-19. IZQUIERDO.



#PARTE: 6RF199555H

SOPORTES SOPORTES SOPORTES



GRUPO **AUTOMOTIVE**
PARTES ELECTRICAS, S.A. DE C.V.



321838

\$
243.60

SOPORTE DE MOTOR /TRANSMISION
HYUNDAI ACCENT 4CIL 1.6L 14-17,
ATTITUDE 4CIL 1.4L 12-15, ATTITUDE
4CIL 1.6L 12-15, ELANTRA 4CIL 1.8L
11-16, ELANTRA 4CIL 2.0L 14-16,
KIA FORTE 4CIL 1.8L 14-18, FORTE
4CIL 2.0L 14-18, RIO 4CIL 1.6L 12-17.
21830-1W100, 21830-3Y100,
21830-R200.
7488

#PARTE: 21830-1R000

362926

\$
525.00

SOPORTE DE MOTOR AUDI Q3
2.0L 13-16, VOLKSWAGEN
TIGUAN 2.0L 08-17.
DELANTERO.

#PARTE: 5N0199262K



351862

\$
208.95

SOPORTE DE MOTOR
CHEVROLET ASTRA 1.8L 00-05,
ASTRA H 2.0L T 06-08, ZAFIRA
1.8L 00-05. TRANSMISION
ESTANDAR. DELANTERO.

#PARTE: 90575186

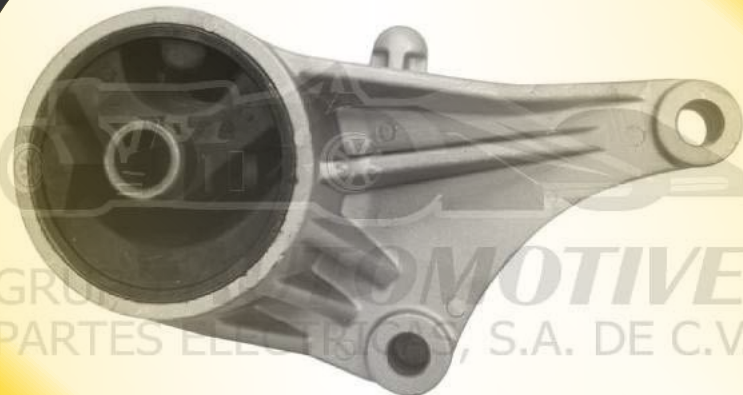

SOPORTES SOPORTES SOPORTES



GRUPO **AUTOMOTIVE**
PARTES ELECTRICAS, S.A. DE C.V.

385767

\$
208.95



GRUPO **AUTOMOTIVE**
PARTES ELECTRICAS, S.A. DE C.V.

SOPORTE DE MOTOR
CHEVROLET ASTRA 1.8L
00-05, ZAFIRA 1.8L 00-05,
ZAFIRA 2.2L 05-06.
TRANSMISION AUTOMATICA.
DELANTERO.

#PARTE: 90538576

354566

\$
208.95

SOPORTE DE MOTOR
CHEVROLET ASTRA 1.8L 00-05,
ZAFIRA 1.8L 00-05.
TRANSMISION ESTANDAR.

#PARTE: 90575456

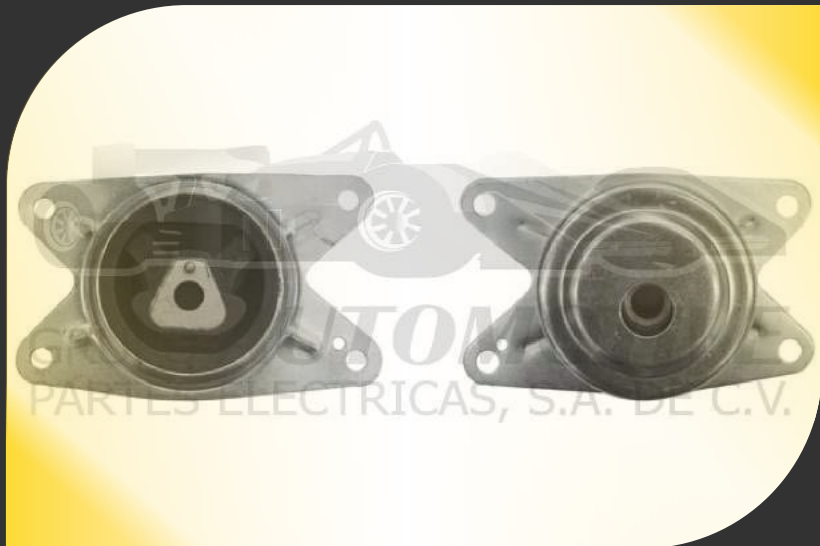

GRUPO **AUTOMOTIVE**
PARTES ELECTRICAS, S.A. DE C.V.

369518

\$
208.95

SOPORTE DE MOTOR
CHEVROLET ASTRA 1.8L 00-05,
ZAFIRA 1.8L 00-05.
TRANSMISION ESTANDAR.
DELANTERO.

#PARTE: 9156951

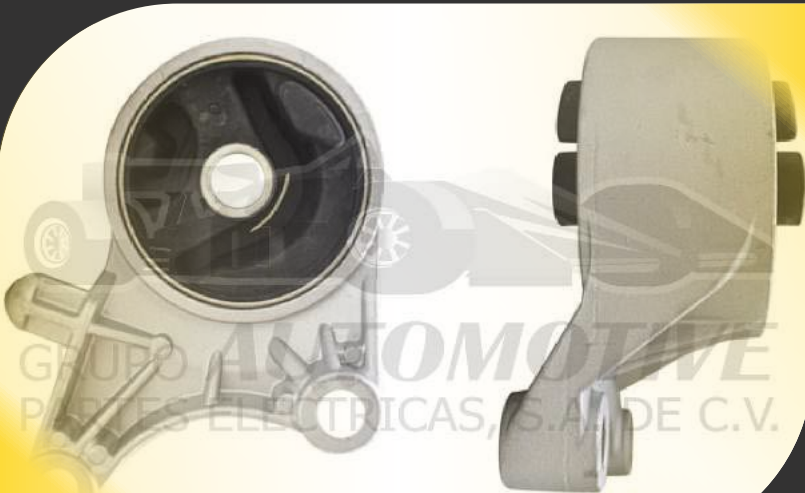

GRUPO **AUTOMOTIVE**
PARTES ELECTRICAS, S.A. DE C.V.

SOPORTES SOPORTES SOPORTES



GRUPO **AUTOMOTIVE**
PARTES ELECTRICAS, S.A. DE C.V.

357726

\$

196.35

SOPORTE DE MOTOR
CHEVROLET ASTRA 4CIL 1.8L
00-08, ASTRA 4CIL 2.0L 04-08,
ASTRA 4CIL 2.2L 00-08, ASTRA
4CIL 2.4L 04-08, ZAFIRA 4CIL 1.8L
00-08, ZAFIRA 4CIL 2.0L 04-08,
ZAFIRA 4CIL 2.2L 00-08, ZAFIRA
4CIL 2.4L 04-08. DERECHO.
5684178

#PARTE: 90575772

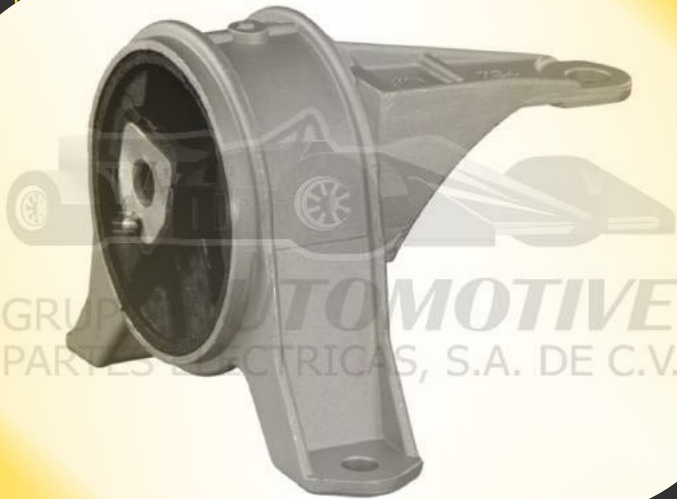

354027

\$

219.45

SOPORTE DE MOTOR
CHEVROLET AVEO 1.6L 08-18,
PONTIAC G3 1.6L 06-09.
TRASERO.

#PARTE: 96535402



353154

\$

340.20

SOPORTE DE MOTOR
CHEVROLET AVEO 1.6L 09-11.
TRANSMISION AUTOMATICA.
IZQUIERDO.
96535499

#PARTE: 96535505



GRUPO **AUTOMOTIVE**
PARTES ELECTRICAS, S.A. DE C.V.

SOPORTES SOPORTES SOPORTES



GRUPO **AUTOMOTIVE**
PARTES ELECTRICAS, S.A. DE C.V.



346617

\$
252.00

SOPORTE DE MOTOR CHEVROLET BUICK
CITATION 6CIL 3.4L 02-07, CITATION 6CIL
3.5L 02-07, CITATION 6CIL 3.6L 04-07,
CHEVROLET UPLANDER 6CIL 3.5L 05-09,
OLDSMOBILE SILHOUETTE 6CIL 3.4L 6CIL
3.4L 97-04, PONTIAC AZTEK 6CIL 3.4L
01-05, MONTANA 6CIL 3.4L 99-05,
MONTANA 6CIL 3.5L 99-05, MONTANA
6CIL 3.9L 99-05. DELANTERO SUPERIOR.
7123

#PARTE: 10274661

344536

\$
173.25

SOPORTE DE MOTOR
CHEVROLET CHEVY 1.6L
95-12, MONZA 1.6L 96-02.
DELANTERO SUPERIOR
DERECHO.

#PARTE: 90445300



352982

\$
136.50

SOPORTE DE MOTOR
CHEVROLET CHEVY 1.6L
95-12. SIN AIRE
ACONDICIONADO. DERECHO.

#PARTE: 90445298



SOPORTES SOPORTES SOPORTES



GRUPO **AUTOMOTIVE**
PARTES ELECTRICAS, S.A. DE C.V.

328332

\$
110.25



SOPORTE DE MOTOR
CHEVROLET CHEVY 1.6L
97-01. (CON AIRE
ACONDICIONADO). TRASERO.

#PARTE: 93230328

322860

\$
172.20

SOPORTE DE MOTOR
CHEVROLET CORSA 02-08,
MERIVA 03-09, TORNADO
02-09. TRASERO SUPERIOR.

#PARTE: 93302286



GRUPO **AUTOMOTIVE**
PARTES ELECTRICAS, S.A. DE C.V.

381225

\$
235.20

SOPORTE DE MOTOR
CHEVROLET CORSA 1.8L
02-09, TORNADO 1.8L 03-19,
MERIVA 1.8L 06-08.
TRANSMISION ESTANDAR,
EASY TRONIC. DELANTERO.

#PARTE: 93302281



GRUPO **AUTOMOTIVE**
PARTES ELECTRICAS, S.A. DE C.V.

SOPORTES SOPORTES SOPORTES



GRUPO **AUTOMOTIVE**
PARTES ELECTRICAS, S.A. DE C.V.

385548

\$
360.15

SOPORTE DE MOTOR
CHEVROLET CRUZE 1.8L 10-15.
TRANSMISION AUTOMATICA.
IZQUIERDO.
13248552

#PARTE: 13248554



GRUPO **AUTOMOTIVE**
PARTES ELECTRICAS, S.A. DE C.V.

384751

\$
501.90

SOPORTE DE MOTOR
CHEVROLET CRUZE 1.8L 10-17.
DERECHO.

#PARTE: 13248475

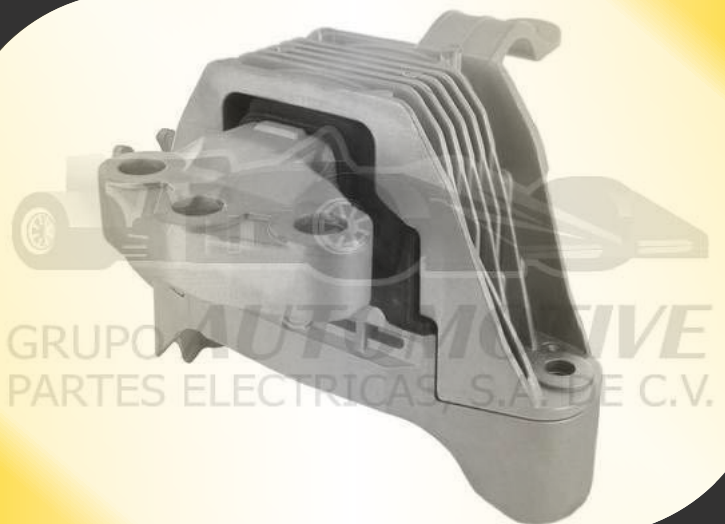

GRUPO **AUTOMOTIVE**
PARTES ELECTRICAS, S.A. DE C.V.

386306

\$
243.60

SOPORTE DE MOTOR
CHEVROLET CRUZE 1.8L 4CIL
10-16. TRASERO.
0684224
00684224

#PARTE: 13248630



GRUPO **AUTOMOTIVE**
PARTES ELECTRICAS, S.A. DE C.V.

SOPORTES SOPORTES SOPORTES



GRUPO **AUTOMOTIVE**
PARTES ELECTRICAS, S.A. DE C.V.

385519

\$
360.15

SOPORTE DE MOTOR
CHEVROLET CRUZE 1.8L 4CIL
10-17. IZQUIERDO.

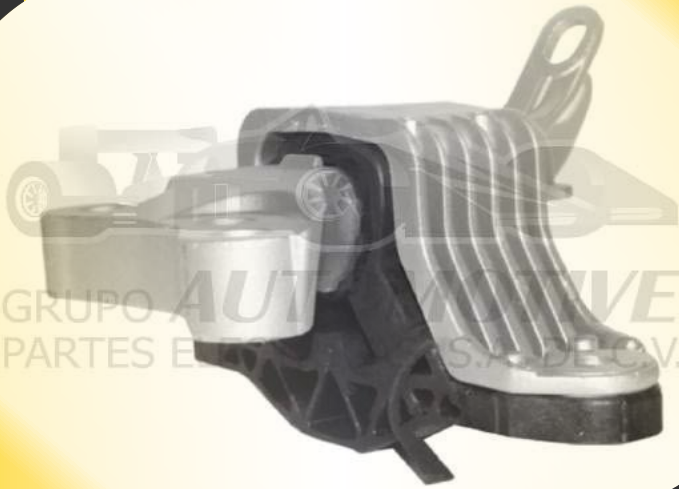

GRUPO **AUTOMOTIVE**
PARTES ELECTRICAS, S.A. DE C.V.

#PARTE: 13248551

314560

\$
422.10

SOPORTE DE MOTOR
CHEVROLET MALIBU 4CIL 2.4L
08-12, PONTIAC G6 4CIL 2.4L
08-10. DELANTERO.



GRUPO **AUTOMOTIVE**
PARTES ELECTRICAS, S.A. DE C.V.

#PARTE: 24100456

324520

\$
257.25

SOPORTE DE MOTOR
CHEVROLET OPTRA 06-10.
TRASERO DERECHO.

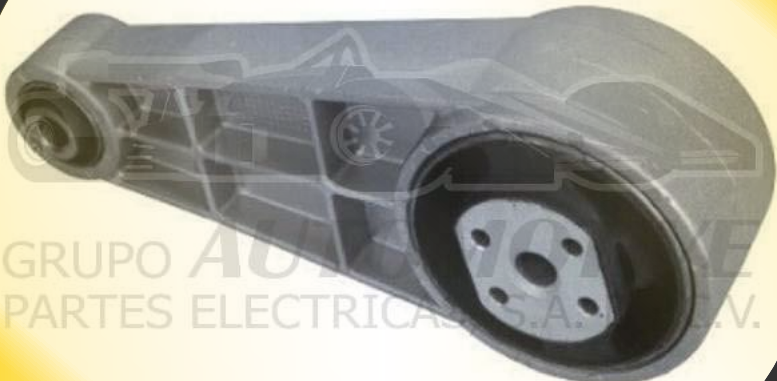

GRUPO **AUTOMOTIVE**
PARTES ELECTRICAS, S.A. DE C.V.

#PARTE: 96852452

SOPORTES SOPORTES SOPORTES



GRUPO **AUTOMOTIVE**
PARTES ELECTRICAS, S.A. DE C.V.

315534

\$
172.20

SOPORTE DE MOTOR
CHEVROLET OPTRA 2.0L
06-10. DERECHO.

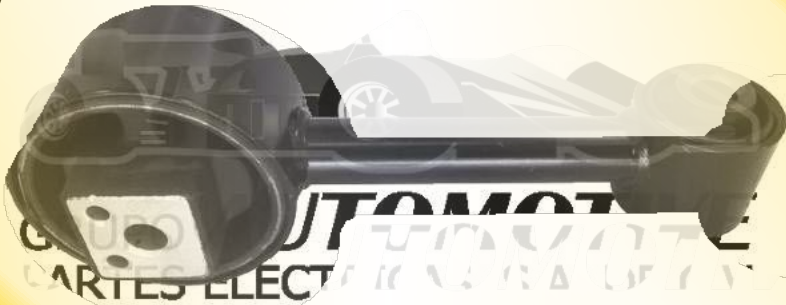

#PARTE: 96550315

337213

\$
205.80

SOPORTE DE MOTOR
CHEVROLET SONIC 2012-2018,
TRAX 2014-2019. 96852632,
96852634, 95493723.
TRASERO.
95350019



#PARTE: 95493721

321956

\$
219.45

SOPORTE DE MOTOR
CHEVROLET SPARK 1.2L 11-20,
BEAT 1.2L 18-20. TRASERO.



#PARTE: 95211295

GRUPO **AUTOMOTIVE**
PARTES ELECTRICAS, S.A. DE C.V.

SOPORTES SOPORTES SOPORTES



GRUPO **AUTOMOTIVE**
PARTES ELECTRICAS, S.A. DE C.V.

336690

\$
360.15

SOPORTE DE MOTOR
CHEVROLET SPARK 4CIL 1.2L
13-15. DERECHO.
95946675

#PARTE: 95136669

332015

\$
313.95

SOPORTE DE MOTOR HONDA
ACCORD 4CIL 2.4L 13-17.
DELANTERO.

#PARTE: 50830T2FA01

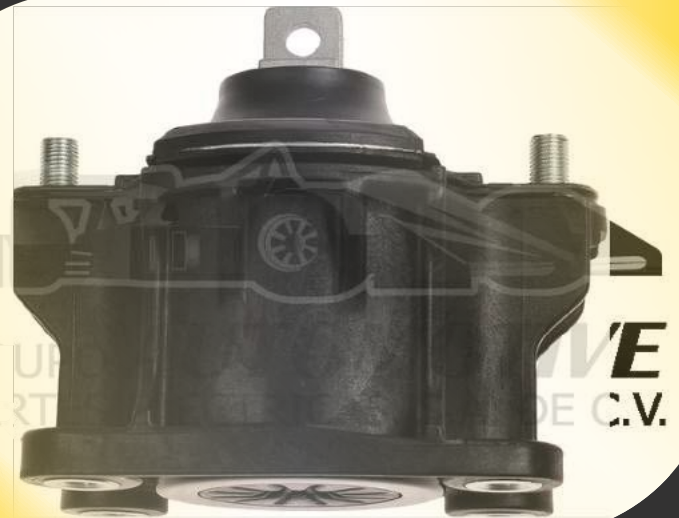

350830

\$
374.85

SOPORTE DE MOTOR HONDA
ACCORD 4CIL 2.4L 2003-2007.
DELANTERO.

#PARTE: 50830SDAA02

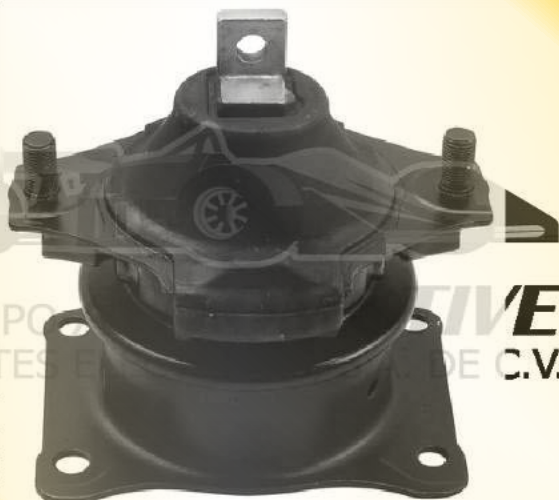

SOPORTES SOPORTES SOPORTES



GRUPO **AUTOMOTIVE**
PARTES ELECTRICAS, S.A. DE C.V.

350872

\$
181.65

SOPORTE DE MOTOR
HONDA ACCORD 4CIL
2003-2007. TRANSMISION
SUPERIOR.

#PARTE: 50870SDAA01

322026

\$
313.95

SOPORTE DE MOTOR HONDA
BR-V 16-22, CITY 09-18.
DERECHO.

#PARTE: 50822TF0J02

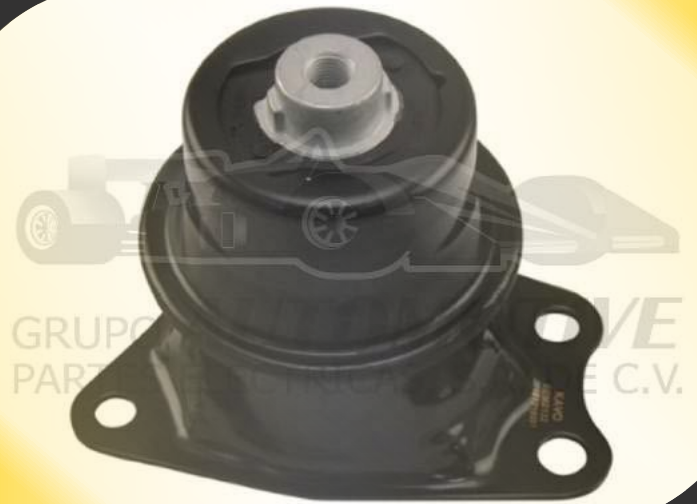

350898

\$
266.70

SOPORTE DE MOTOR HONDA
BR-V 4CIL 1.5L 18-19, CITY
4CIL 1.5L 09-13, CR-Z 4CIL 1.5L
11-15, FIT 4CIL 1.5L
09-12. 50890-TF0-911.
TRASERO.
7568

#PARTE: 50890TF0901

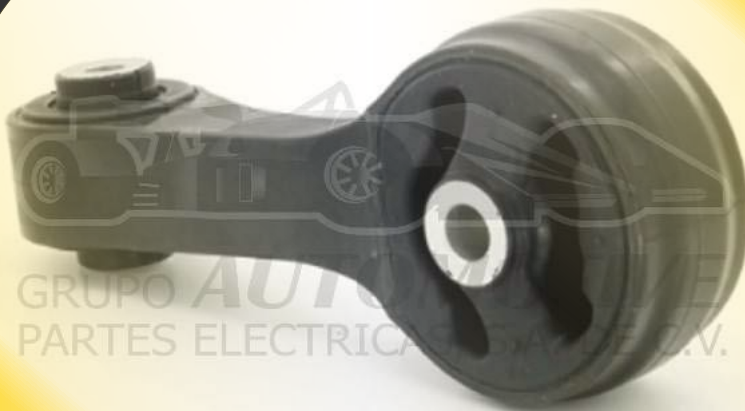

SOPORTES SOPORTES SOPORTES



GRUPO **AUTOMOTIVE**
PARTES ELECTRICAS, S.A. DE C.V.

359123

\$
661.50

SOPORTE DE MOTOR HONDA
CITY 4CIL 1.5L 14-19, FIT 4CIL
1.5L 15-19, HR-V 4CIL 1.8L
16-18. TRANSMISION
MANUAL. IZQUIERDO.

#PARTE: 50850T5A912



GRUPO **AUTOMOTIVE**
PARTES ELECTRICAS, S.A. DE C.V.

358235

\$
400.05

SOPORTE DE MOTOR HONDA
CITY 4CIL 1.5L 14-19, FIT 4CIL
1.5L 15-19, HR-V 4CIL 1.8L
16-22. DERECHO.
7839-H

#PARTE: 50822T9A013



GRUPO **AUTOMOTIVE**
PARTES ELECTRICAS, S.A. DE C.V.

385535

\$
388.50

SOPORTE DE MOTOR HONDA
CITY 4CIL 1.5L 14-19, FIT 4CIL
1.5L 15-19. TRANSMISION
AUTOMATICA. DERECHO.
7764

#PARTE: 50850T5H003



GRUPO **AUTOMOTIVE**
PARTES ELECTRICAS, S.A. DE C.V.

SOPORTES SOPORTES SOPORTES



GRUPO **AUTOMOTIVE**
PARTES ELECTRICAS, S.A. DE C.V.

385011

\$
313.95

SOPORTE DE MOTOR HONDA
CIVIC 1.8L 4CIL 12-15.
TRANSMISION MANUAL.

#PARTE: 50850TROA01

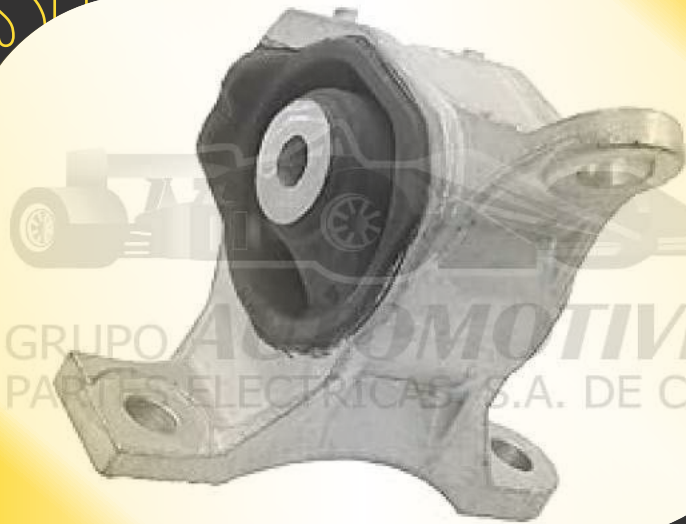

GRUPO **AUTOMOTIVE**
PARTES ELECTRICAS, S.A. DE C.V.

358222

\$
783.30

SOPORTE DE MOTOR
HONDA CIVIC 4CIL 1.5L
16-20, CIVIC 4CIL 2.0L
15-23. 50820-TBA-A01,
50820-TBA-A03. DERECHO.
8900-H

#PARTE: 50820TBAA02



GRUPO **AUTOMOTIVE**
PARTES ELECTRICAS, S.A. DE C.V.

381533

\$
191.10

SOPORTE DE MOTOR HONDA
CIVIC 4CIL 1.7L 01-05.
TRASERO.

#PARTE: 50810S5A013



GRUPO **AUTOMOTIVE**
PARTES ELECTRICAS, S.A. DE C.V.

SOPORTES SOPORTES SOPORTES



GRUPO **AUTOMOTIVE**
PARTES ELECTRICAS, S.A. DE C.V.

389026

\$
243.60

SOPORTE DE MOTOR HONDA
CIVIC 4CIL 1.8L 06-11.
TRASERO INFERIOR.

#PARTE: 50890SNA02

350827

\$
619.50

SOPORTE DE MOTOR
HONDA CIVIC 4CIL 1.8L 12-15.
50820-TR0-A81. DERECHO.
7894

#PARTE: 50820TROA71



GRUPO **AUTOMOTIVE**
PARTES ELECTRICAS, S.A. DE C.V.

576320

\$
228.90

SOPORTE DE MOTOR HONDA
CR-V 4CIL 2.4L 07-11.
DERECHO.
7632

#PARTE: 50880SWAA81

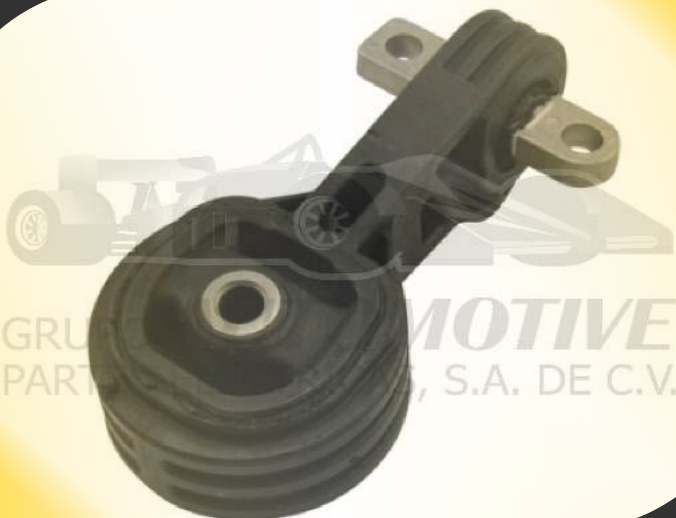

GRUPO **AUTOMOTIVE**
PARTES ELECTRICAS, S.A. DE C.V.

SOPORTES SOPORTES SOPORTES



GRUPO **AUTOMOTIVE**
PARTES ELECTRICAS, S.A. DE C.V.

383817

\$
234.15

SOPORTE DE MOTOR HONDA
CR-V 4CIL 2.4L 12-14.
DELANTERO.
600055

#PARTE: 50830T0AA81

382507

\$
604.80

SOPORTE DE MOTOR
HONDA CR-V 4CIL 2.4L 12-15.
50820-T0T-H01. DERECHO.
7663-H

#PARTE: 50820T0AA01



GRUPO **AUTOMOTIVE**
PARTES ELECTRICAS, S.A. DE C.V.

385813

\$
270.90

SOPORTE DE MOTOR
HONDA CR-V 4CIL 2.4L
12-16. 50850-T1W-A11. (PARA
TRANSMISION)
7650

#PARTE: 50850T0AA81

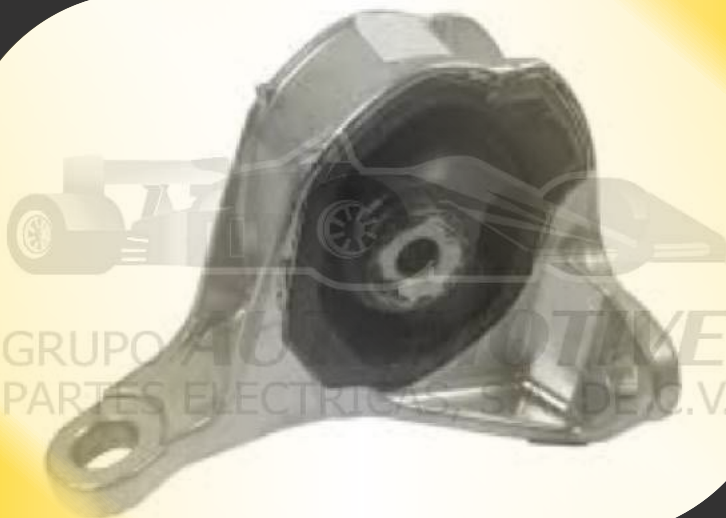

GRUPO **AUTOMOTIVE**
PARTES ELECTRICAS, S.A. DE C.V.

SOPORTES SOPORTES SOPORTES



GRUPO **AUTOMOTIVE**
PARTES ELECTRICAS, S.A. DE C.V.



321138

\$
243.60

SOPORTE DE MOTOR HONDA
FIT 4CIL 1.5L 07-08.
DELANTERO DERECHO.
50821SAA013

#PARTE: 50821SAA013

386014

\$
92.40

SOPORTE DE MOTOR HONDA
ODYSSEY 6CIL 3.5L 05-06.
TRASERO INFERIOR.

#PARTE: 50806SHJA01



381504

\$
995.40

SOPORTE DE MOTOR HONDA
ODYSSEY 6CIL 3.5L 08-16.
TRASERO.

#PARTE: 50810TK8A01



SOPORTES SOPORTES SOPORTES



GRUPO **AUTOMOTIVE**
PARTES ELECTRICAS, S.A. DE C.V.



312580

\$
374.85

SOPORTE DE MOTOR HONDA,
ACURA MDX 4CIL 2.4L 03-08,
TL 6CIL 3.5L 06-08, TSX 4CIL
2.4L 04-08, HONDA ACCORD
4CIL 2.4L 03-07. TRASERO.
7207-H

#PARTE: 50810SDAA02

390823

\$
228.90

SOPORTE DE MOTOR HONDA,
ACURA RDX 4CIL 2.3L 07-12,
HONDA CIVIC 4CIL 1.8L 06-11.
TRASERO.

#PARTE: 50890SNAAB2

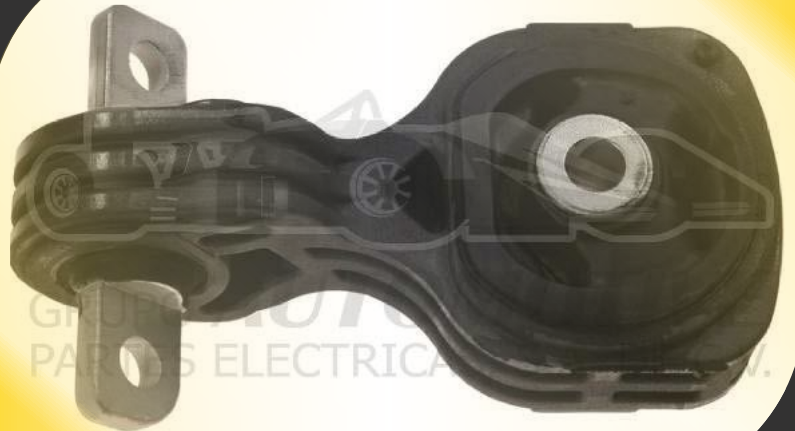

318124

\$
360.15

SOPORTE DE MOTOR
HYUNDAI ACCENT 4CIL 1.6L
06-11, ATTITUDE 4CIL 1.4L
06-11, ATTITUDE 4CIL 1.6L
06-11, KIA RIO 4CIL 1.6L 06-11,
RIO 5 4CIL 1.6L 06-11.
21810-1G000. DERECHO.
7616-H

#PARTE: 21810-1E000



SOPORTES SOPORTES SOPORTES



GRUPO **AUTOMOTIVE**
PARTES ELECTRICAS, S.A. DE C.V.



573465

\$
205.80

SOPORTE DE MOTOR HYUNDAI
ACCENT 4CIL 1.6L 06-11,
ATTITUDE 4CIL 1.4L 06-11,
ATTITUDE 4CIL 1.6L 06-11, KIA
RIO 4CIL 1.6L 06-11, RIO5 4CIL
1.6L 06-11. 21910-1G200,
21910-1G050. DELANTERO.
7346

#PARTE: 21910-1G000

395304

\$
313.95

SOPORTE DE MOTOR HYUNDAI ACCENT
4CIL 1.6L 14-17, ATTITUDE 4CIL 1.4L 12-15,
ATTITUDE 4CIL 1.6L 12-15, ELANTRA 4CIL
1.8L 11-16, ELANTRA 4CIL 2.0L 14-16, KIA
FORTE 4CIL 1.8L 14-18, FORTE 4CIL 2.0L
14-18, RIO 4CIL 1.6L 12-17, SOUL 4CIL 1.6
14-19, SOUL 4CIL 2.0L 14-19. 21950-1W100,
21950-A4000, 21950-2V000, 21950-3X100,
21950-1W000, 21950-2V000, 21950-1W100.
TRASERO.
7437

#PARTE: 21950-3X000

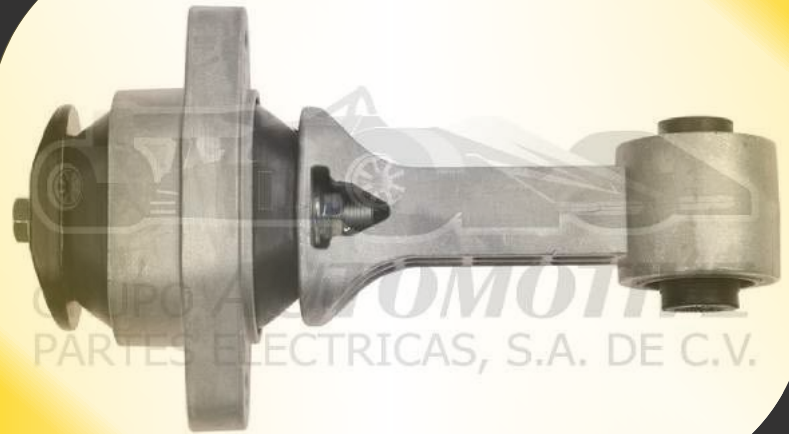

384529

\$
130.20

SOPORTE DE MOTOR HYUNDAI
ATOS 4CIL 1.0L 00-05.
21840-02000. DELANTERO.
7127 / 6951

#PARTE: 21840-05200



SOPORTES SOPORTES SOPORTES



GRUPO **AUTOMOTIVE**
PARTES ELECTRICAS, S.A. DE C.V.

315839

\$
313.95

SOPORTE DE MOTOR
HYUNDAI ATTITUDE 4CIL 1.6L
2014, ACCENT 4CIL 1.6L 12-17,
ELANTRA 4CIL 1.8L 14-16, KIA
RIO 4CIL 1.6L 12-17, FORTE
2014, FORTE 5 4CIL 2.0L 2014.
(TRANSMISION).

#PARTE: 21830-1R050



320819

\$
422.10

SOPORTE DE MOTOR HYUNDAI
ELANTRA 1.8L / 2.0L 17-19, KIA
FORTE 4CIL 2.0L 17-19.
DERECHO.

#PARTE: 21810-F2000



381301

\$
337.05

SOPORTE DE MOTOR KIA RIO
4CIL 1.6L 12-17. 21810-1R010,
21810-2V500, 21810-2V000,
21810-1W000. DERECHO.
7486-H

#PARTE: 21810-3X000

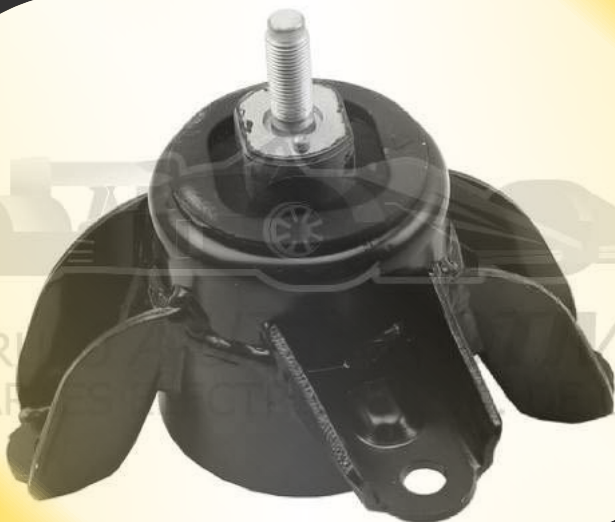

SOPORTES SOPORTES SOPORTES



GRUPO **AUTOMOTIVE**
PARTES ELECTRICAS, S.A. DE C.V.



391227

\$
196.35

SOPORTE DE MOTOR KIA
SORENTO 4CIL 2.4L 11-13,
SORENTO 6CIL 3.5L 11-13,
HYUNDAI SANTA FE 4CIL 2.4L
10-12. DELANTERO.

#PARTE: 21910-2B200

321065

\$
219.45

SOPORTE DE MOTOR NISSAN
200SX 4CIL 1.6L 95-98, NX 4CIL
1.6L 91-93, SENTRA 4CIL 2.0L
96-06, TSUBAME 4CIL 1.6L
93-04, TSUBAME 4CIL 2.0L 93-04,
TSURU III 4CIL 1.6L 92-16, TSURU
III 4CIL 2.0L 92-16. DERECHO.
6970

#PARTE: 11210-0M600



576435

\$
595.35

SOPORTE DE MOTOR NISSAN
MARCH 4CIL 1.6L 11-23, NOTE
4CIL 1.6L 14-18, VERSA 4CIL
1.6L 12-19. DERECHO.
7643-H

#PARTE: 11210-1H50A



SOPORTES SOPORTES SOPORTES



GRUPO **AUTOMOTIVE**
PARTES ELECTRICAS, S.A. DE C.V.

S35410

\$
100.80

SOPORTE DE MOTOR NISSAN
SENTRA 4CIL 1.6L 96-00,
TSUBAME 4CIL 1.6L 93-04,
TSURU III 4CIL 1.6L 12-17.
DELANTERO.

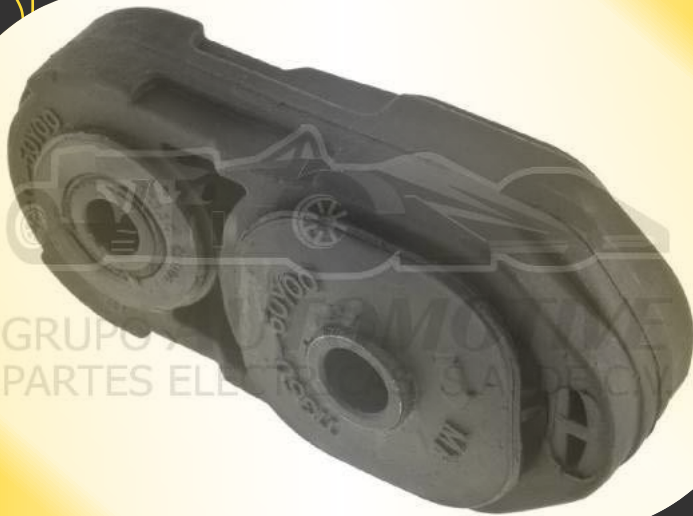

#PARTE: 11350-41B00

S22508

\$
219.45

SOPORTE DE MOTOR NISSAN
TSURU 4CIL 1.6L 92-17. IZ-
QUIERDO.

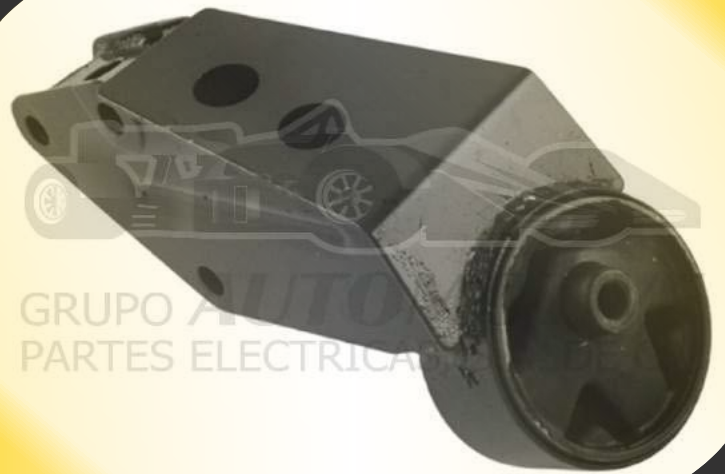

#PARTE: 11220-50Y05

S64104

\$
120.75

SOPORTE DE MOTOR NISSAN
TSURU II 1992-2017.
DELANTERO DERECHO.



#PARTE: 11210-F4100

SOPORTES SOPORTES SOPORTES



GRUPO **AUTOMOTIVE**
PARTES ELECTRICAS, S.A. DE C.V.

311355

\$
116.55

SOPORTE DE MOTOR NISSAN
TSURU II 92-17, SENTRA 1.6L
91-97, SENTRA 2.0L 91-99,
TSUBAME 1.6L 93-98, LUCINO
2.0L 91-99. DELANTERO.

#PARTE: 11320-50Y00

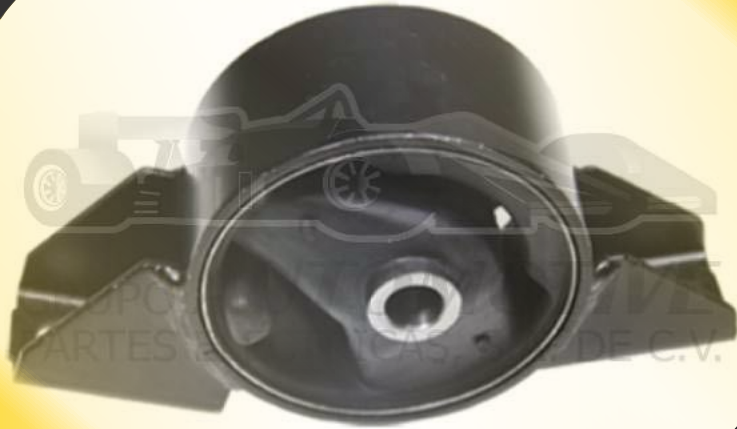

385826

\$
224.70

SOPORTE DE MOTOR PARA
TRANSMISION HONDA FIT
4CIL 1.5L 07-08, CITY 1.3L
05-08. 50805-SAA-013.

#PARTE: 50805SAA982



306742

\$
144.90

SOPORTE DE MOTOR PARA
TRANSMISION NISSAN
MARCH 4CIL 1.6L 11-23, NOTE
4CIL 1.6L 14-19, VERSA 4CIL
1.6L 12-19.
7406

#PARTE: 11220-1HA0B



SOPORTES SOPORTES SOPORTES



GRUPO **AUTOMOTIVE**
PARTES ELECTRICAS, S.A. DE C.V.

395552

\$

417.90



SOPORTE DE MOTOR VOLKSWAGEN
BORA 1.9L TDI / 2.0L TFSI 05-10
(TRANSMISION ESTANDAR Y
AUTOMATICA) GTI 2.0L T 05-09
(TRANSMISION ESTANDAR), CADDY
1.6L 15-20, AUDI A3 2.0L T 04-12
(TRANSMISION ESTANDAR), SEAT
LEON 1.8L T 07-13.

#PARTE: 1K0199555Q

398489

\$

157.50

SOPORTE DE MOTOR
VOLKSWAGEN EUROVAN T5
2.0L TDI 05-20. (GOMA).
DELANTERO.



#PARTE: 7H0199848G

398492

\$

417.90



SOPORTE DE MOTOR
VOLKSWAGEN EUROVAN T5
2.0L TDI 2005-2020. TRASERO.

#PARTE: 7H0199849

SOPORTES SOPORTES SOPORTES



GRUPO **AUTOMOTIVE**
PARTES ELECTRICAS, S.A. DE C.V.

398519

\$
287.70

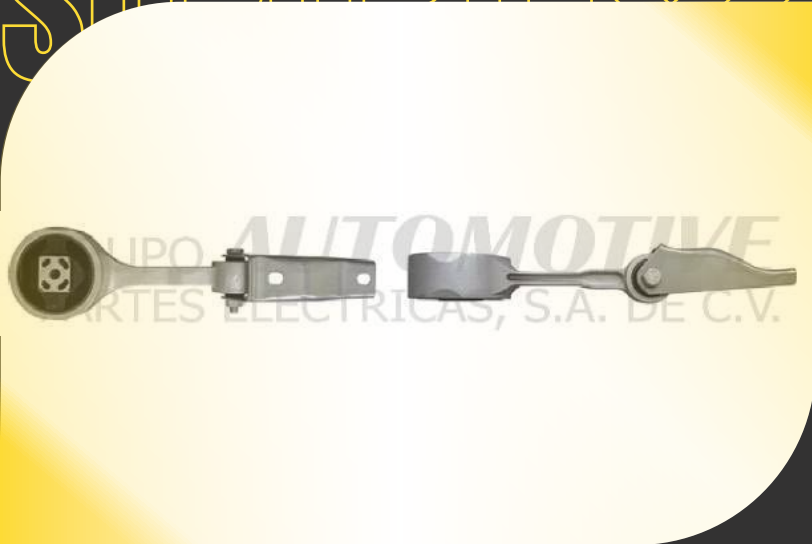

SOPORTE DE MOTOR
VOLKSWAGEN GOL 1.6L 09-20,
POLO 1.6L 03-07, CROSSFOX 1.6L
06-17, LUPO 1.6L 05-09, SAVEIRO
1.6L 09-20, SPORTVAN 1.6L
06-10, DERBY 2.0L 95-09, SEAT
IBIZA 1.6L 03-08, CORDOBA 1.6L
03-09. (HUESO-TORSION).

#PARTE: 6Q0199851AB

391678

\$
289.80

SOPORTE DE MOTOR
VOLKSWAGEN GOL 1.6L 09-20,
SAVEIRO 1.6L 09-20. DERECHO.

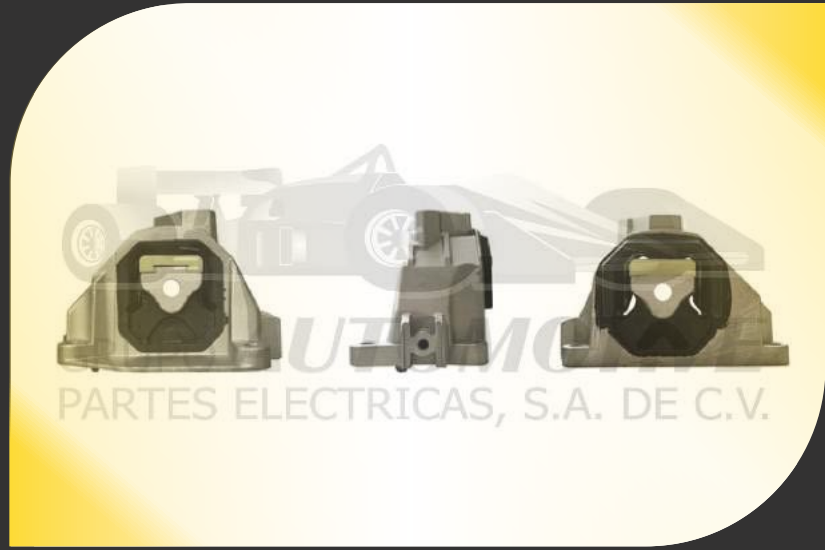

#PARTE: 5U0199167



355981

\$
166.95

SOPORTE DE MOTOR
VOLKSWAGEN GOLF A1 MK7
1.4L TURBO 14-18, JETTA A4
MK7 1.4L TURBO 18-22, SEAT
LEON MK3 1.4L TURBO 13-20,
AUDI A3 1.4L TURBO 13-20.
TRASERO

#PARTE: 5Q0199855AA

SOPORTES SOPORTES SOPORTES



GRUPO **AUTOMOTIVE**
PARTES ELECTRICAS, S.A. DE C.V.

359558

\$
507.15

SOPORTE DE MOTOR
VOLKSWAGEN GOLF VII 1.4L
TSI 15-19, SEAT LEON 1.4L T
14-20, ATECA 1.4L T 17-19,
AUDI Q2 1.4L TSI 16-20.

#PARTE: 5Q0199555BG



398679

\$
78.75

SOPORTE DE MOTOR
VOLKSWAGEN GTI 2.0L T 05-10,
BORA 2.5L FSI 05-10, SEAT LEON
1.4L TSI 07-13, ALTEA 1.8L TSI
07-14, AUDIA A3 1.4L T 04-12.
TRANSMISION AUTOMATICA 6
VELOCIDADES. DELANTERO
INFERIOR

#PARTE: 1K0199867



399424

\$
110.25

SOPORTE DE MOTOR
VOLKSWAGEN JETTA 1.8L
88-92, GOLF 1.8L 88-92, JETTA III
1.8L 93-99, GOLF III 1.8L 93-99,
DERBY 1.8L 95-09, SEAT
CORDOBA 1.6L 99-02, IBIZA 1.6L
00-02. HIDRAULICO (VASITO).
LATERAL IZQUIERDO.

#PARTE: 357199402B



SOPORTES SOPORTES SOPORTES



GRUPO **AUTOMOTIVE**
PARTES ELECTRICAS, S.A. DE C.V.

355994

\$
417.90



GRUPO **AUTOMOTIVE**
PARTES ELECTRICAS, S.A. DE C.V.

SOPORTE DE MOTOR
VOLKSWAGEN JETTA 2.5L FSI
11-18, BORA 2.5L FSI 05-10,
SPORTWAGEN 2.5L 10-16, NEW
BEETLE 2.5L 11-19, CADDY 1.6L
15-20, SEAT ALTEA 2.0L FSI
07-14, TOLEDO 2.0L FSI 06-09.
IZQUIERDO.

#PARTE: 1K0199555N

359590

\$
365.40

SOPORTE DE MOTOR
VOLKSWAGEN JETTA IV 1.8L
T / 2.0L 99-15, BEETLE 1.8L
T / 2.0L 98-11. TRANSMI-
SION ESTANDAR. IZQUIERDO.
1J0199555AH

#PARTE: 1J0199555AJ

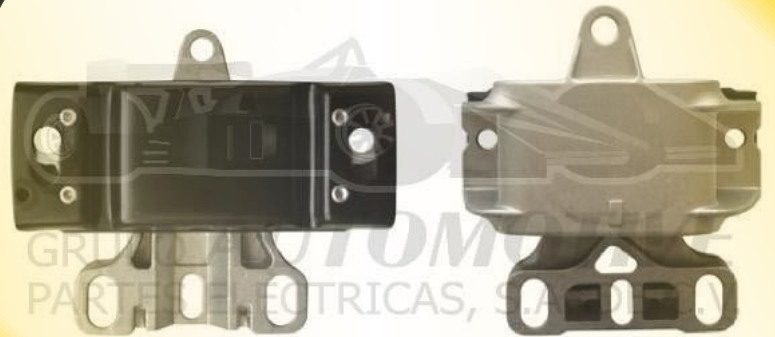

GRUPO **AUTOMOTIVE**
PARTES ELECTRICAS, S.A. DE C.V.

326993

\$
521.85



GRUPO **AUTOMOTIVE**
PARTES ELECTRICAS, S.A. DE C.V.

SOPORTE DE MOTOR
VOLKSWAGEN JETTA IV 2.0L
99-15, GOLF IV 2.0L 99-07,
BEETLE 2.0L 98-11, AUDI A3
1.8L T 96-03, SEAT LEON 1.8L
01-06, TOLEDO 1.8L 01-05.
DERECHO

#PARTE: 1J0199262BF

SOPORTES SOPORTES SOPORTES



GRUPO **AUTOMOTIVE**
PARTES ELECTRICAS, S.A. DE C.V.

399263

\$
521.85

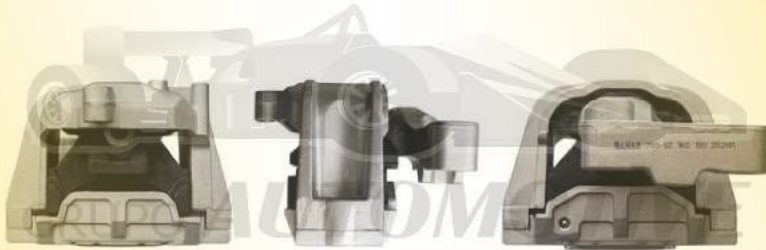

GRUPO **AUTOMOTIVE**
PARTES ELECTRICAS, S.A. DE C.V.

SOPORTE DE MOTOR
VOLKSWAGEN JETTA VI 2.0L
T 11-18, BORA 2.0L TFSI 05-10,
PASSAT 2.0L T 05-10, NEW
BEETLE 2.0L T 11-19,
SPORTWAGEN 2.5L 10-16, SEAT
ALTEA 2.0L TSI 07-14. DERECHO.

#PARTE: 1K0199262AM

319625

\$
966.00

SOPORTE DE MOTOR
VOLKSWAGEN JETTA VI 2.5L
FSI 11-18, BORA 2.5L FSI 05-10,
NEW BEETLE 2.5L 11-19,
PASSAT 2.5L 12-18. DIRECCION
HIDRAULICA. DERECHO.

#PARTE: 1J0199262DA



GRUPO **AUTOMOTIVE**
PARTES ELECTRICAS, S.A. DE C.V.

393822

\$
277.20



GRUPO **AUTOMOTIVE**
PARTES ELECTRICAS, S.A. DE C.V.

SOPORTE DE MOTOR
VOLKSWAGEN PASSAT 1.8L T
98-04, AUDI A4 1.8L T 94-00, A4
1.8L T 00-05. CON CAPUCHON.
DERECHO

#PARTE: 8D0199382L

SOPORTES SOPORTES SOPORTES



GRUPO **AUTOMOTIVE**
PARTES ELECTRICAS, S.A. DE C.V.

393791

\$
261.45



SOPORTE DE MOTOR
VOLKSWAGEN PASSAT 1.8L T
98-04, AUDI A4 1.8L T 94-00,
A4 1.8L T 00-05. IZQUIERDO /
DERECHO.

GRUPO **AUTOMOTIVE**
PARTES ELECTRICAS, S.A. DE C.V.

#PARTE: 8D0199379J

367918

\$
480.90

SOPORTE DE MOTOR
VOLKSWAGEN POLO 1.6L
03-07, SEAT CORDOBA 1.6L
03-09, IBIZA 1.6L 03-08.
TRANSMISION ESTANDAR.



GRUPO **AUTOMOTIVE**
PARTES ELECTRICAS, S.A. DE C.V.

#PARTE: 6Q0199167BM

362225

\$
431.55

SOPORTE DE MOTOR
VOLKSWAGEN VIRTUS 20-23,
T-CROSS 20-24. DELANTERO.

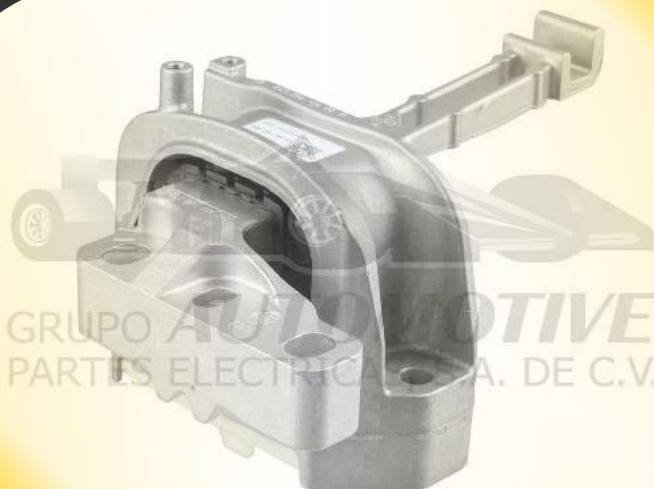

GRUPO **AUTOMOTIVE**
PARTES ELECTRICAS, S.A. DE C.V.

#PARTE: 2Q0199262BM

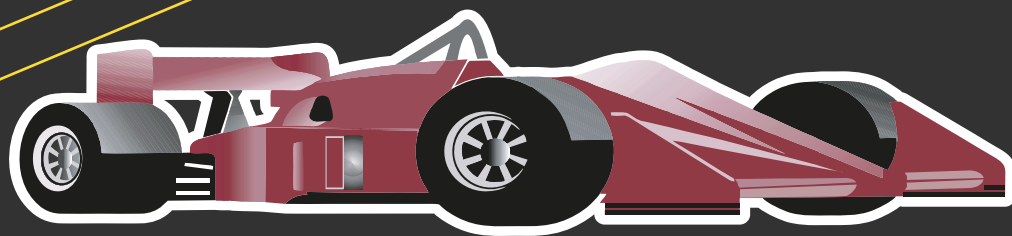

GRUPO **AUTOMOTIVE**
PARTES ELECTRICAS, S.A. DE C.V.



www.automotive.com.mx

 (5352) 3645,8383,
2917,7845 y 8110

 Jbpedidos1@automotive.com.mx

 *Azcapotzalco, Ciudad de México*

**PRECIOS SUJETOS A CAMBIOS SIN PREVIO AVISO
NO VÁLIDA PARA OTRAS PROMOCIONES**