

AUTOPARTES ELÉCTRICAS
AUTOMOTIVE

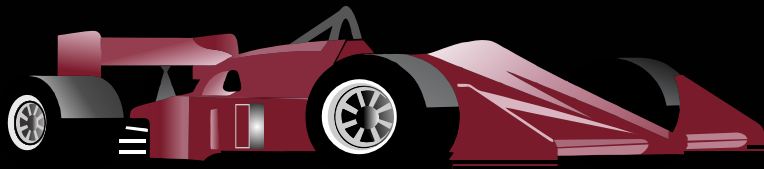

CATÁLOGO MARCHAS



MARCHAS

Autopartes Eléctricas Automotive es una empresa que tiene 34 años de experiencia en el mercado y por lo tanto se consolida como una de las empresas líderes a nivel nacional. Nuestras marchas se distinguen por la gran calidad, máxima variedad y competitividad en precios. Manejando todos los sistemas de vehículos. Actualmente distribuimos a toda la república mexicana, convirtiendonos en tu distribuidor de confianza.

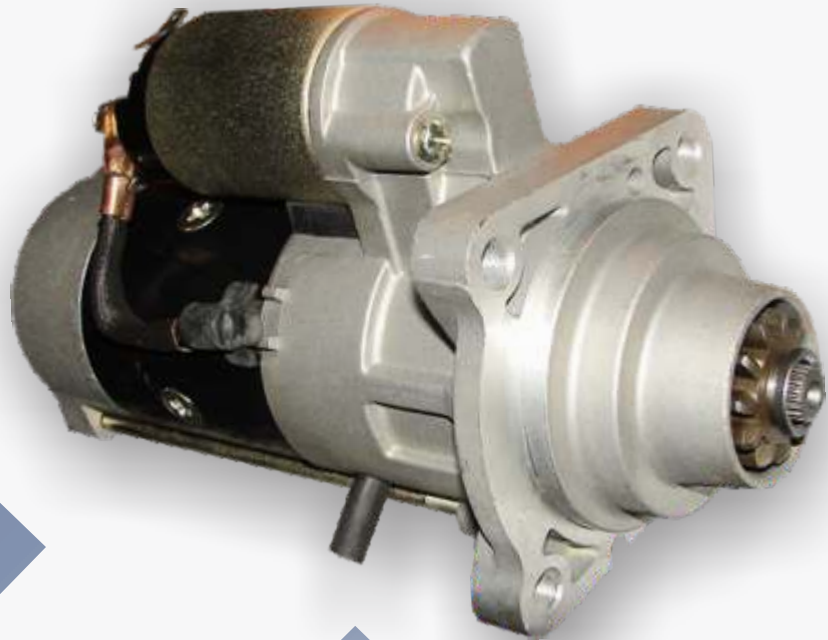

INDICE

MARCHAS	BOSCH	1 - 32
MARCHAS	DELCO	33 - 56
MARCHAS	FORD	57 - 65
MARCHAS	HITACHI	66 - 69
MARCHAS	HYUNDAI	70
MARCHAS	ISKRA	71
MARCHAS	LUCAS	72
MARCHAS	MARELLI	73
MARCHAS	MITSUBA	74
MARCHAS	MITSUBISHI	75- 90
MARCHAS	NIPPONDENSO	91 - 99
MARCHAS	PRESTOLITE	100 - 101
MARCHAS	VALEO	102 - 110



MARCHAS SISTEMA
BOSCH



Marchas Sistema Bosch



CLAVE: M40096
NUM. PARTE: 0001369022
MARCHA BOSCH COMPLETA 3KW 12V JOHN DEERE 4CIL
10 DIENTES CW
LESTER 16563, 17095 90000044009



CLAVE: M585N2
NUM. PARTE: SR8585N
MARCHA BOSCH
CADILLAC ESCALADE 5.3 2001-2005
CHEVROLET SILVERADO 2500 5.3 1998-2000
CHEVROLET SILVERADO 1500 5.3 4X4 1998-2007
CHEVROLET SUBURBAN 1500 5.3 4X4 FFV 2006-2014
CHEVROLET AVALANCHE 5.3 FFV 4X4 2006-2011
CHEVROLET EXPRESS 1500 5.3 2002-2007
CHEVROLET SUBURBAN 1500 5.3 FFV 2008-2011
CHEVROLET C1500 5.3 2001-2002
CHEVROLET SONORA 5.3 2002-2006
CHEVROLET TAHOE 5.3 4X4 FFV 2006-2014
CHEVROLET AVALANCHE 1500 5.3 2001-2006
CHEVROLET SILVERADO 2500 5.3 2000-2003
CHEVROLET AVALANCHE 1500 5.3 FFV 2004-2005
CHEVROLET AVALANCHE 1500 5.3 FFV 4X4 2004-2005
CHEVROLET AVALANCHE 5.3 FFV 4X4 2006-2013
CHEVROLET SUBURBAN 1500 5.3 4X4 FFV 2006-2011
GMC (GENERAL MOTORS CORP) SIERRA 1500 5.3 FFV 4X4 2006-2011
GMC (GENERAL MOTORS CORP) SIERRA 1500 5.3 FFV 2011-2013
GMC (GENERAL MOTORS CORP) SIERRA 1500 5.3 FFV 4X4 2011-2013
GMC (GENERAL MOTORS CORP) SIERRA 1500 5.3 FFV 2010-2011



CLAVE: M05230
NUM. PARTE: 0986MN0523
MARCHA BOSCH
CHEVROLET SILVERADO 2500 5.7 1996-2002

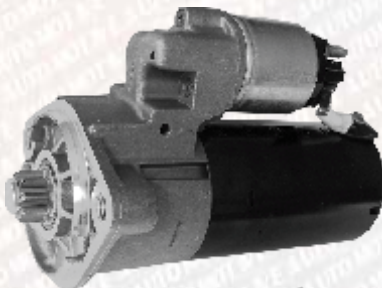

CLAVE: M50553
NUM. PARTE: 0001125055
MARCHA BOSCH
VW CRAFTER 2.5L TDI 08=>, RF78-M28 12V (DER)

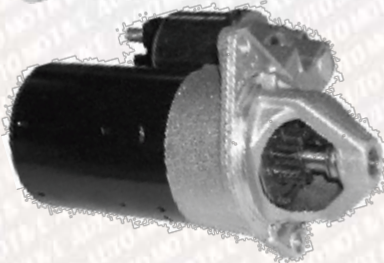

CLAVE: M70981
NUM. PARTE: 0001107098
MARCHA BOSCH PMGR 1.1KW 12V CHEVROLET
ASTRA 1.8LT (00-03)
9 DIENTES CW
0001107077



Marchas Sistema Bosch

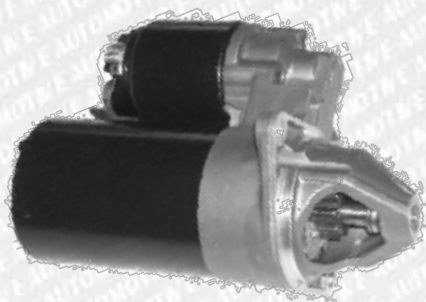

CLAVE: M50199
NUM. PARTE: 6004AA0020
MARCHA BOSCH CHEVY
95-2004 12V 1.1 KW 9007045019



CLAVE: M70046
NUM. PARTE: 6004AA3012
MARCHA BOSCH CHRYSLER CAMION D-600
9007047004



CLAVE: M70033
NUM. PARTE: 6004AA3009
MARCHA BOSCH CHRYSLER CAMION
9007047003 6004AA30006

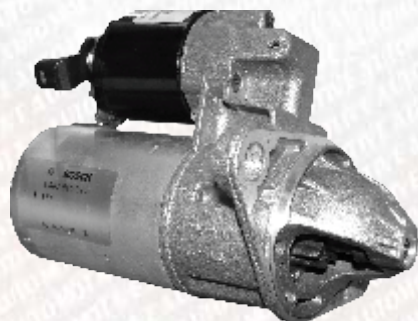

CLAVE: M50204
NUM. PARTE: 9007045020
MARCHA BOSCH CHRYSLER DODGE
NEON/STRATUS (95-97)
8 DIENTES CW
LESTER 17560

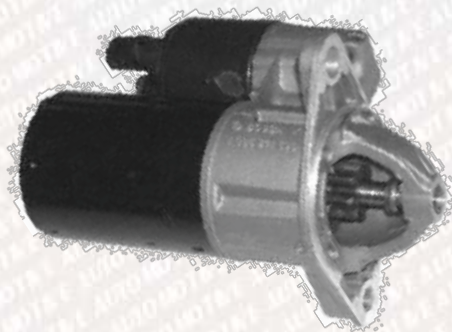

CLAVE: M00189
NUM. PARTE: 6004AA0018
MARCHA BOSCH 1.1KW 12V CHRYSLER DODGE NEON
(98-99) CIRRUS 2000 2L, STRATUS 2L (98-00)
8 DIENTES CW
9007045018



Marchas Sistema Bosch

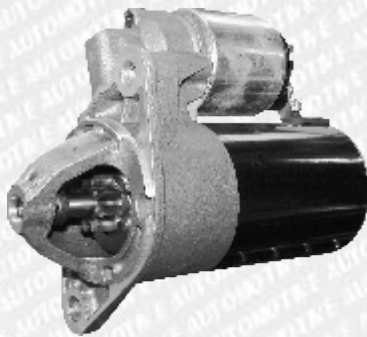

CLAVE: M00235
NUM. PARTE: 6004AA0023
MARCHA BOSCH PMGR 12V CHRYSLER DODGE
NEON 2L (00-02)
8 DIENTES CW
LESTER 17790

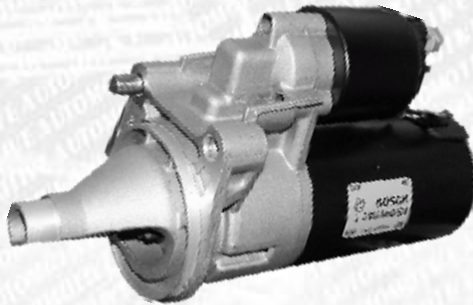

CLAVE: M91068
NUM. PARTE: 0986MN0601
MARCHA BOSCH CHRYSLER VOYAGER 3.3 2000-2008,
CHRYSLER NEW YORKER 3.3 1989-1993,
CHRYSLER VOYAGER 3.3I 1990-1994,
CHRYSLER VOYAGER 3.3I 1991-1994,
DODGE VOYAGER 3.3 1996-2000



CLAVE: M96005
NUM. PARTE: 0986MN0600
MARCHA BOSCH DODGE SHADOW 2.5
HATCHBACK 1987-1994, DODGE DAKOTA 2.5 1988-1995,
DODGE DAKOTA 2.5 1996-1996,
JEEP WRANGLER 2.5 1996-2002

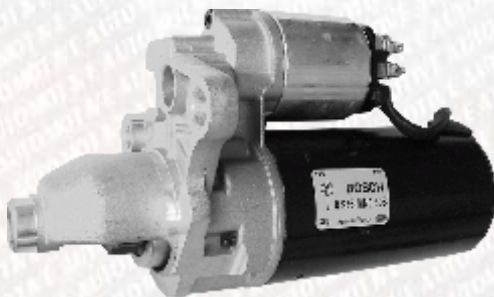

CLAVE: M06085
NUM. PARTE: 0986MN0608
MARCHA BOSCH
DODGE RAM 1500 3.9 1993-2003
DODGE RAM 1500 3.9 VAN 1993-2003
DODGE RAM 1500 3.9 PICKUP 4X4 1993-2001
DODGE RAM 1500 3.9 VAN 1995-1997

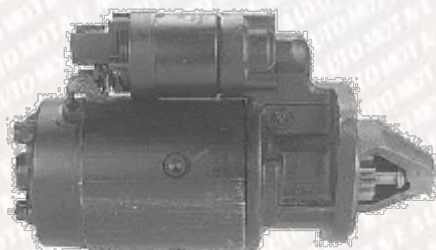

CLAVE: M20343
NUM. PARTE: 6004AA0021
MARCHA BOSCH COMPLETA VW
9007042025 9007042024



Marchas Sistema Bosch

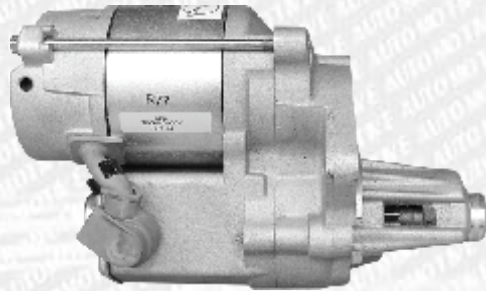

CLAVE: M65049

NUM. PARTE: SR6504N

MARCHA BOSCH

CHRYSLER DART 5.2 V8 1968-1981

CHRYSLER LE BARON 5.9L V8 STATION WAGON 1978-1982

CHRYSLER LE BARON 5.9 COUPE 1977-1982

CHRYSLER VALIANT SUPER BEE 5.2 V8 1970-1980

CHRYSLER LE BARON 5.9 1977-1979

CHRYSLER LE BARON 5.9 1977-1982

CHRYSLER LE BARON 5.9 1977-1979

CHRYSLER CORDOBA 5.9 CONVERTIBLE 1974-1979

DODGE D150 3.9 1987-1991

DODGE RAMCHARGER 5.9 1988-1992

DODGE RAMCHARGER 5.9 4X4 1988-1992

DODGE RAM 3.9 PICKUP 1991-1998

DODGE RAM 4000 5.9 CHASSIS 2004-2009

DODGE RAM 2500 5.2 PICKUP 1993-1998

DODGE DURANGO 5.9 1997-2003

DODGE D150 3.9 1991-1993

DODGE RAM 1500 5.2 PICKUP 1995-2001

DODGE RAM 2500 5.9 PICKUP 1993-2002

DODGE RAM 2500 5.2 VAN 1993-2003

DODGE RAM 2500 5.9 VAN 1993-2003

DODGE RAM 3500 5.9 PICKUP 1993-2002

DODGE RAM 3500 5.2 VAN 1998-2003

DODGE RAM 3500 5.9 VAN 1993-2003

DODGE RAM 2500 5.9 PICKUP 1993-2001

DODGE DURANGO 5.2 1997-2000

DODGE RAM 2500 5.9 PICKUP 2006-2008

DODGE RAMCHARGER 5.9 1992-1993

DODGE RAM 1500 5.2 VAN 1992-2003

DODGE B2500 5.2 1994-1998

DODGE RAM 1500 5.9 PICKUP 1997-2001

DODGE RAMCHARGER 5.9 1995-2001

DODGE RAM 1500 5.2 PICKUP 1998-2002

DODGE RAM 2500 5.9 PICKUP 4X4 2006-2009

DODGE RAM 3500 5.9 PICKUP 1993-2002

DODGE D300 5.9 1971-1979

DODGE D100 5.9 1970-1979

DODGE B2500 5.9 1994-1998

DODGE RAM 3500 5.9 VAN 1994-1998

DODGE RAMCHARGER 5.2 1999-2001

DODGE RAM 3500 5.9I CUSTOM V8 1995-1998

DODGE RAM 1500 5.2 VAN 1996-1997

DODGE RAM 1500 5.9 VAN 1998-2002

DODGE RAM 2500 5.2 PICKUP 2000-2002

DODGE MAGNUM 5.9 V8 1980-1982

DODGE RAM 3500 5.9 PICKUP 4X4 1999-1999

DODGE RAM 3500 5.9 1999-1999

DODGE MONACO 5.2 V8 1970-1977

DODGE DART 5.2 1970-1976

DODGE RAM 4000 5.9 PICKUP 1995-2002

DODGE CORONET 5.2 1969-1971

DODGE MONACO 5.2 V8 STATION WAGON 1970-1977

DODGE RAM 3.9 1990-1993

DODGE MONACO 5.9 1973-1978



Marchas Sistema Bosch



CLAVE: M20267
NUM. PARTE: 6004AA0031
MARCHA BOSCH COMBI PANEL E.
AGUA (87-2002) 12V 1.1KW
9007042026



CLAVE: M25103
NUM. PARTE: F000AL0125
MARCHA BOSCH
VW (VOLKSWAGEN) DERBY 1.8 MI 1998-2003
VW (VOLKSWAGEN) COMBI PANEL 1.8 1997-2001
VW (VOLKSWAGEN) COMBI PANEL 1.8 1995-1997
VW (VOLKSWAGEN) CORSAR 1.8 1984-1988
VW (VOLKSWAGEN) COMBI 1.8 1989-1994



CLAVE: M70223
NUM. PARTE: 0001121008
MARCHA BOSCH COMPLETA PMGR 12V 1.1KW
AUDI TT 1.8L (00-06) BEETLE 1.8L (99-04) BEETLE 2L (98-05)
JETTA 1.8/2L (00-05) GOLF
10 DIENTES CCW
LESTER 17780 0001107022

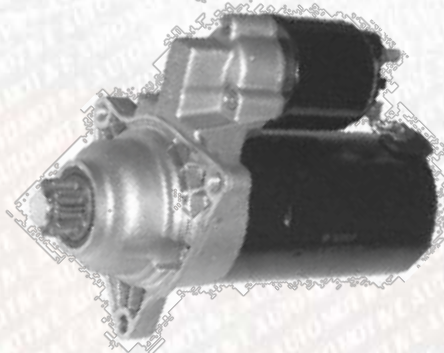

CLAVE: M50318
NUM. PARTE: 0001125031
MARCHA BOSCH 2KW 12V VW EUROVAN 2.5/2.8L (96-00)
10 DIENTES CCW
LESTER 17750 0001125001

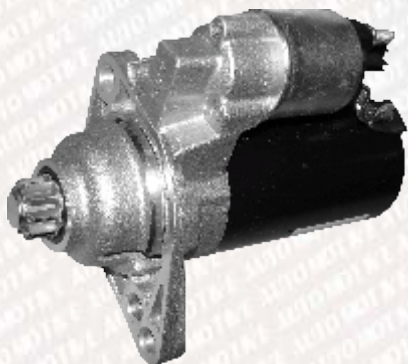

CLAVE: M23018
NUM. PARTE: 0001123012
MARCHA BOSCH 1.7KW 12V EUROVAN TDI
JETTA TDI 1.9L (06)
11 DIENTES CCW
LESTER 32673, 32674



Marchas Sistema Bosch

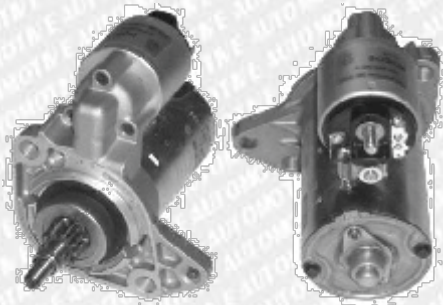

CLAVE: M00192
NUM. PARTE: 6004AA0019
MARCHA BOSCH GOLF JETTA 87-92

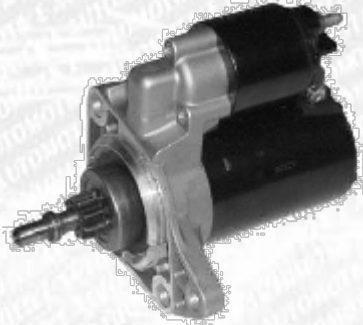

CLAVE: M70207
NUM. PARTE: 0001107020
MARCHA BOSCH 1.1 KW 12V CABRIO 2L (95-01)
GOLF/ JETTA 2L (97-99) JETTA 1.9L, PASSAT 2L
9 DIENTES CCW
LESTER 17415 0001107021



CLAVE: M10063
NUM. PARTE: F000AL0507
MARCHA BOSCH POINTER 1.8 Y 2.0 LT 98-2008
F000AL0502



CLAVE: M24100
NUM. PARTE: 0001121024
MARCHA BOSCH V.W. POLO, SEAT,
CORDOBA 12V RF74-M50

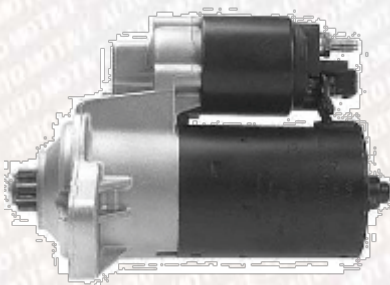

CLAVE: M00061
NUM. PARTE: 0001121006
MARCHA BOSCH PMGR 1.1KW 12V VW BEETLE 1.8L/2L
(98-04), CABRIO 2L (02) GOLF 1.8L (01-03) 2L (99-06)
JETTA 1.8L (01-04) 2L (00-05)
9 DIENTES CCW
LESTER 17781



Marchas Sistema Bosch

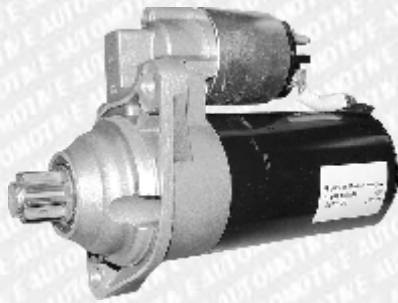

CLAVE: M50392
NUM. PARTE: 0001125039
MARCHA BOSCH 1.8KW 12V GOLF 2.8L (95-02) JETTA 2.8L (94-02) PASSAT 2.8L (97-02)
9 DIENTES CCW
LESTER 17417, 17819



CLAVE: M24008
NUM. PARTE: 0001212400
MARCHA BOSCH 0.95KW 12V
CABRIOLET/GOLF/JETTA 1.8L (85-90)
9 DIENTES CW
LESTER 17122

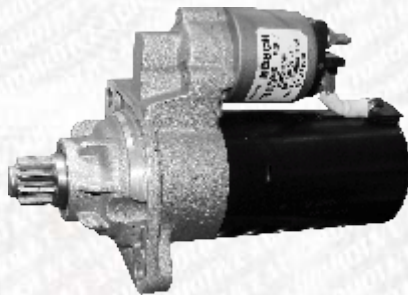

CLAVE: M50481
NUM. PARTE: 0001125048
MARCHA BOSCH 2KW 12V VW SHARAN (01-05)
SEAT ALHAMBRA (01-05) GOLF/JETTA 1.8L (01)
10 DIENTES CCW
LESTER 17820 0001125018



CLAVE: M14023
NUM. PARTE: 0001121402
MARCHA BOSCH VW 1.1KW 12V RF70-M25(L)
JETTA PASSAT, AUDI A3, BORA GLI TURBO, 2L (06-08)
GOLF GTI/SEAT LEON 2L (07-08) CONECTOR REDONDO
C/1 TERMINAL PLANA
10 DIENTES CCW
LESTER 17970



CLAVE: M24024
NUM. PARTE: 0001122402
MARCHA BOSCH PMGR VW 1.1KW 12V BORA 2.5L (05-06)
JETTA 2.5L (06-08) STYLE (06-08) PRESTIGE,
EXCLUSIVE GLI, TRIPTONIC, BEETLE 2.5L (06-08)
NEW BEETLE SPORT 2.5L (06-08) CABRIO, GLX.
CONECTOR REDONDO C/1 TERMINAL PLANA
10 DIENTES
LESTER 17969



Marchas Sistema Bosch

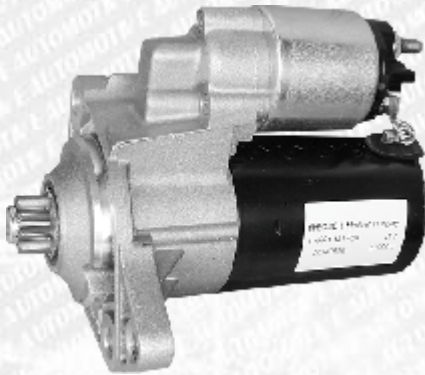

CLAVE: M21286

NUM. PARTE: 0001121028

MARCHA BOSCH

AUDI A3 1.8 T 1998-2003,

AUDI A3 1.8 T 1999-2000,

AUDI A3 1.8 T 2000-2003,

SEAT IBIZA 1.6 2001-2002,

SEAT CORDOBA 1.6 2001-2002,

SEAT LEON 1.8 T 2000-2004,

SEAT LEON 1.8 2002-2004,

SEAT TOLEDO 1.8 T 2000-2004,

SEAT TOLEDO 1.8 2001-2003,

SEAT LEON 1.8 T CUPRA R 2003-2003,

VW (VOLKSWAGEN) JETTA 1.8 2005-2008,

VW (VOLKSWAGEN) JETTA 2.0 2000-2004,

VW (VOLKSWAGEN) JETTA 1.8 1998-2004,

VW (VOLKSWAGEN) JETTA 2.0 GLS 1992-1998,

VW (VOLKSWAGEN) JETTA 2.0 1998-2000



CLAVE: M14124

NUM. PARTE: 0001121412

MARCHA BOSCH AUDI A3 2.0 TFSI 2008-2014,

AUDI A3 2.0 TFSI 2005-2008,

AUDI A3 2.0 TFSI SPORTBACK 2005-2008,

AUDI A3 2.0 TFSI SPORTBACK 2008-2014,

AUDI TT 2.0 TFSI COUPE 2007-2010,

AUDI S3 2.0 TFSI QUATTRO 2008-2014

SEAT LEON 2.0 TFSI 2005-2009,

SEAT ALTEA FREETRACK 2.0 TFSI 4WD 2009-2009,

VW (VOLKSWAGEN) BORA 2.0 WOLFSBURG GLI 2008-2010,

VW (VOLKSWAGEN) GOLF V 2.0 GTI 2005-2008,

VW (VOLKSWAGEN) GOLF V 2.0 GTI 2007-2010,

VW (VOLKSWAGEN) GOLF V 2.0 GTI 2007-2010,

VW (VOLKSWAGEN) EOS 2.0 FSI 2007-2014

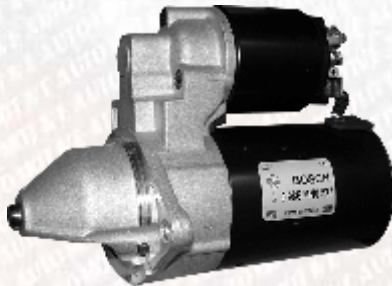

CLAVE: M05272

NUM. PARTE: 0986MN0527

MARCHA BOSCH

CHEVROLET

CORSA SEDAN 1.8 MPFI 2005-2008

CORSA SEDAN 1.8 MPFI 2003-2005

CORSA 1.8 MPFI 2005-2008



CLAVE: M00467

NUM. PARTE: 0001120406

MARCHA BOSCH

VW POLO 1.6L (06-), SEAT IBIZA 1.6L



Marchas Sistema Bosch

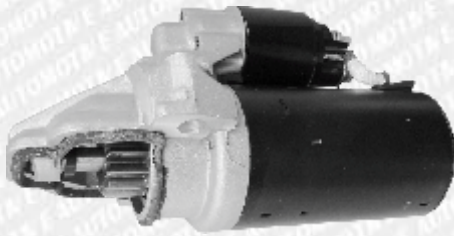

CLAVE: M32439
NUM. PARTE: 33243N
MARCHA SISTEMA BOSCH PMGR 12V.
CITROEN LCV 06-08,
FIAT LCV 06-08,
FORD LCV 06-08,
FORD TRANSIT 2.2L DIESEL,
LAND ROVER 06-13,
PEUGEOT LCV - 06-13
6C1T-11000-AB, 6C1T-11000-AC,
6C1T-11000-AD, 6C1T-11000-AF
12 DIENTES



CLAVE: M12043
NUM. PARTE: 0001120400
MARCHA BOSCH PMGR 0.9KW 12V AUDI,
SEAT IBIZA, CORDOBA 1.6 (03-..)
10 DIENTES CCW



CLAVE: M60408
NUM. PARTE: 0986MN0604
MARCHA BOSCH
DODGE
NEON 2.0 1994-1999
NEON 2.0 R/T 2000-2005
STRATUS 2.0I 16V 2000-2006

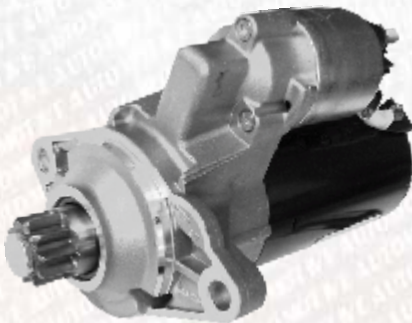

CLAVE: M30167
NUM. PARTE: 0001123016
MARCHA BOSCH
AUDI A3 3.2 SPORTBACK QUATTRO 2005-2008
AUDI A3 3.2 QUATTRO 2004-2004
AUDI TT 1.8 T ROADSTER QUATTRO 2000-2002
AUDI A3 3.2 QUATTRO 2004-2005
AUDI TT 3.2 COUPE QUATTRO 2007-2009
AUDI TT 1.8 T ROADSTER QUATTRO 1999-2000
AUDI TT 1.8 T COUPE QUATTRO 2000-2002
AUDI TT 1.8 T COUPE QUATTRO 2000-2002
AUDI TT 3.2 ROADSTER QUATTRO 2007-2010
AUDI TT 1.8 T COUPE QUATTRO 2002-2006
AUDI TT 1.8 T ROADSTER 2003-2006
VW JETTA 1.9 TDI 2005-2008
VW BORA 1.9 TDI 2006-2014
VW GOLF V 3.2 R32 4MOTION 2007-2008

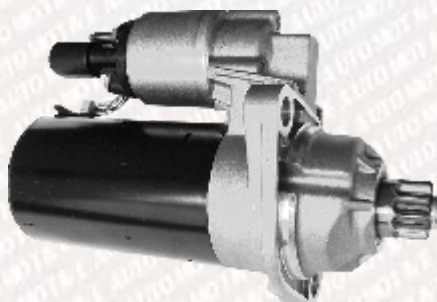

CLAVE: M30141
NUM. PARTE: 0001123014
MARCHA BOSCH
AUDI A3 3.2 SPORTBACK QUATTRO 2005-2008
AUDI TT 3.2 COUPE QUATTRO 2007-2009
AUDI TT 3.2 ROADSTER QUATTRO 2007-2010
VW PASSAT 3.6 FSI CC 2008-2010
VW PASSAT 3.6 FSI 2005-2010



Marchas Sistema Bosch



CLAVE: M26106

NUM. PARTE: 0001121026

MARCHA BOSCH

AUDI A3 1.8 T 1998-2003

AUDI A3 1.8 T 1999-2000

AUDI TT 1.8 T COUPE QUATTRO 2002-2006

AUDI TT 1.8 T ROADSTER 2003-2006

AUDI A3 1.8 T 2000-2003

SEAT IBIZA 1.8 T 2005-2008

SEAT IBIZA 1.8 T CUPRA R 2005-2008

SEAT LEON 1.8 T 2000-2004

SEAT LEON 1.8 2002-2004

SEAT TOLEDO 1.8 2001-2003

VW JETTA 1.8 2005-2008

VW JETTA 2.0 GLS 1992-1998

VW JETTA 2.0 1998-2000

VW GOLF III 2.0 1992-1999

VW NEW BEETLE 1.8 T 2002-2004

VW NEW BEETLE 1.8 T 1999-2001



CLAVE: M09959

NUM. PARTE: 0986MN0995

MARCHA BOSCH

JEEP

WRANGLER 4.0 1997-2007

GRAND CHEROKEE 4.0 1998-2002

GRAND CHEROKEE 4.0 1995-1998

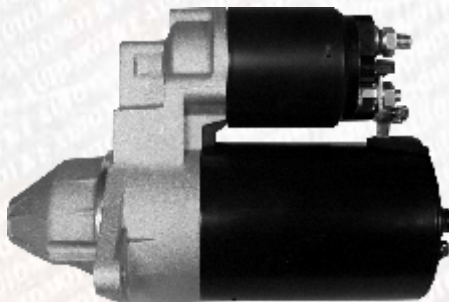

CLAVE: M09115

NUM. PARTE: 40-0911

MARCHA IMPORTACION CHEVY



CLAVE: M10224

NUM. PARTE: 0001121022

MARCHA BOSCH

AUDI TT 1.8 T ROADSTER QUATTRO 2000-2002

AUDI TT 1.8 T ROADSTER QUATTRO 1999-2000

AUDI TT 1.8 T COUPE 2000-2006

AUDI TT 1.8 T COUPE QUATTRO 2002-2006

AUDI TT 3.2 COUPE QUATTRO 2004-2006

AUDI TT 3.2 ROADSTER QUATTRO 2003-2006

SEAT LEON 1.8 T 2000-2004

SEAT ALHAMBRA 1.8 T 2002-2007

SEAT LEON 1.8 T CUPRA R 2004-2006

SEAT LEON 1.8 T CUPRA R 2003-2003

VW JETTA 1.8 2005-2008

VW SHARAN 1.8 T 2002-2008

VW NEW BEETLE 1.8 T 2001-2005

VW NEW BEETLE 1.8 T 2002-2004

VW NEW BEETLE 1.8 T 2004-2005



Marchas Sistema Bosch



CLAVE: M70687
NUM. PARTE: 0001107068
MARCHA BOSCH
AUDI A4 1.8 T 1994-1998

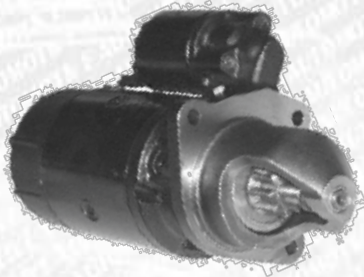

CLAVE: M30547
NUM. PARTE: 9000083054
MARCHA BOSCH COMPLETA 3KW 12V
MERCEDES BENZ TRUCKS CON MOTOR OM352
9 DIENTES CW
LESTER 17106

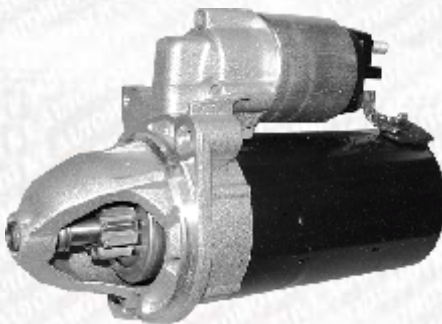

CLAVE: M92500
NUM. PARTE: 0001109250
MARCHA BOSCH PMGR 2.2KW 12V
DODGE SPRINTER VAN 2.7L (04-06)
MERCEDES E CLASS 3.2L (05-06) BENZ FREIGHTLINER
VAN 2.7L (02-06)
10 DIENTES CW
LESTER 18360 0051516601



CLAVE: M40114
NUM. PARTE: 0001367303
MARCHA BOSCH 3KW 12V MERCEDES BENZ
TRUCKS CON MOTOR OM352
9 DIENTES CW
LESTER 17106 9007044002 9007044011

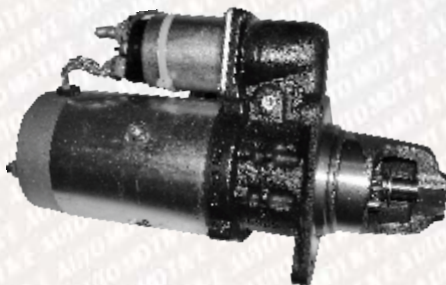

CLAVE: M50027
NUM. PARTE: 0001372005
MARCHA BOSCH 6.2KW 24V MERCEDES BENZ
CITARO, TRAVEGO
11 DIENTES CW
LESTER 30114
001372-005, 457151-0301



Marchas Sistema Bosch

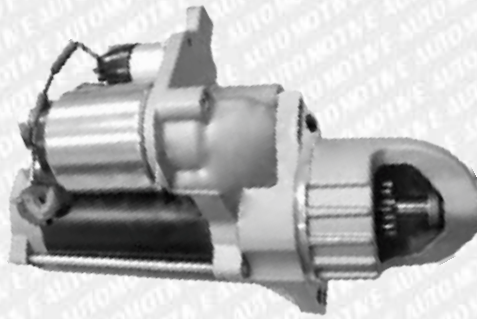

CLAVE: M10338
NUM. PARTE: 0001231033
MARCHA BOSCH 4KW 24V MERCEDES ATEGO,
MARCO POLO ALLEGRO
9 DIENTES CW
LESTER 18364 0001231002



CLAVE: M20064
NUM. PARTE: 0001416002
MARCHA BOSCH KB 5.4KW 24V MASSEY FERGUSON,
MERCEDES BENZ TRUCKS OM 401, 422, 441, 442
9 DIENTES CW
LESTER 18113 003151-4101, 4501;
741031000, 0041516001

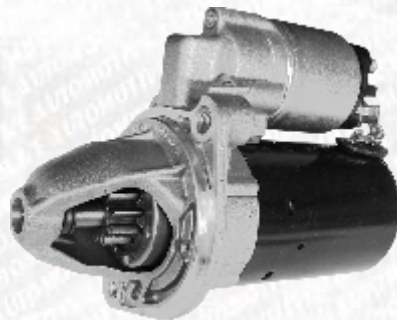

CLAVE: M74035
NUM. PARTE: 0001107403
MARCHA BOSCH
MERCEDES-BENZ C 200 KOMPRESSOR 2001-2002
MERCEDES-BENZ C 200 KOMPRESSOR T-MODELL 2001-2002
MERCEDES-BENZ C 200 KOMPRESSOR SPORTCOUPE 2001-2002
MERCEDES-BENZ SLK 230 KOMPRESSOR 2001-2004
MERCEDES-BENZ SLK 230 KOMPRESSOR 1996-2000
MERCEDES-BENZ C 230 KOMPRESSOR SPORTCOUPE 2002-2003
MERCEDES-BENZ SLK 200 KOMPRESSOR 2003-2004

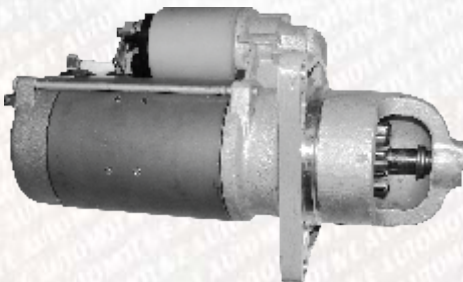

CLAVE: M31001
NUM. PARTE: 0001231004
MARCHA BOSCH 4KW 24V VOLVO B7F, B7L, AUTOBUSES
FM7 7L (01-08), CAMIONES CON MOTOR DIESEL
6.7/7/7.3L
12 DIENTES CW
LESTER 18956 8192965, 3978710

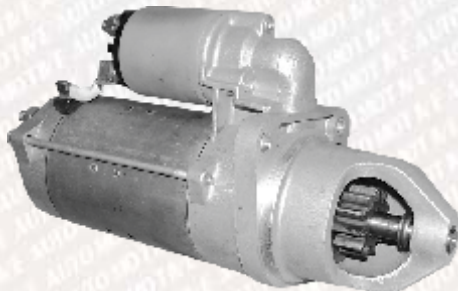

CLAVE: M41015
NUM. PARTE: 0001231014
MARCHA BOSCH 4KW 24V VOLVO FL6 TRUCKS,
MOTORES D6B-180, -220, -250
11 DIENTES CW
LESTER 18957



Marchas Sistema Bosch

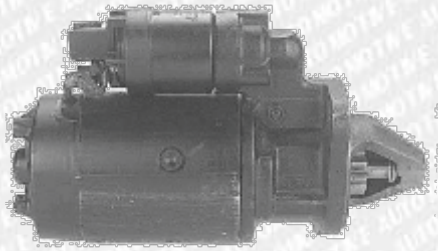

CLAVE: M40143
NUM. PARTE: 0001369023
MARCHA BOSCH 3.1KW 12V TRACTORES FORD,
NEW HOLLAND
10 DIENTES CW
LESTER 18024 9007044014

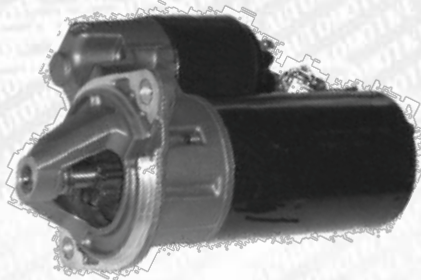

CLAVE: M20051
NUM. PARTE: 6004AA2005
MARCHA BOSCH NISSAN PICK UP D-21 94-2004
6004AA2004



CLAVE: M00016
NUM. PARTE: 6004AA0017
MARCHA BOSCH NISSAN TSURU TSUBAME
6004AA0001 6004AA0002 6004AA0016



CLAVE: M14606
NUM. PARTE: SR146N
MARCHA BOSCH 0.8KW 12V NISSAN PICK UP
2.0/2.2/2.4L (81-89)
8 DIENTES CW
LESTER 16711,16805
NISSAN 23300W0-411, -412, -414

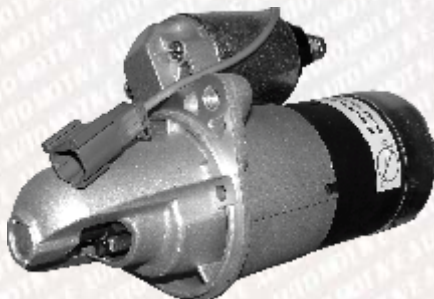

CLAVE: M22627
NUM. PARTE: SR2262N
MARCHA BOSCH 1.2KW 12V NISSAN TSURU GSR 2.0L,
SENTRA 2.0L (91-01)
8 DIENTES CW
LESTER 17246
NISSAN 2330063J-10, -11



Marchas Sistema Bosch

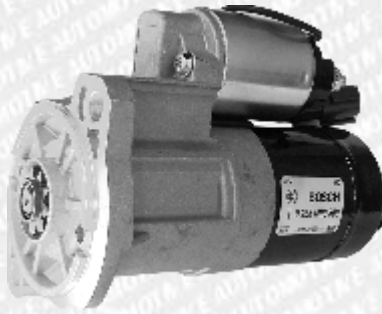

CLAVE: M08007
NUM. PARTE: 0986MN0800
MARCHA BOSCH
NISSAN URVAN 2.4L 2001 EN ADELANTE 121V 1.4KW



CLAVE: M08036
NUM. PARTE: 0986MN0803
MARCHA BOSCH
NISSAN PLATINA 1.6L
RENAULT CLIO 1.6L. 12V 0.9KW

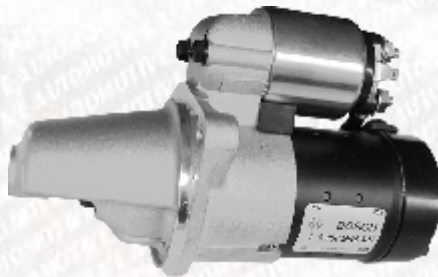

CLAVE: M08078
NUM. PARTE: 0986MN0807
MARCHA BOSCH
NISSAN SENTRA 2.0 2006-2012
NISSAN SENTRA 2.0 1995-2001
NISSAN TSURU III 2.0 16V 1995-1996
NISSAN LUCINO 2.0 1996-1999
NISSAN ALTIMA 1.8i 1996-1997



CLAVE: M08049
NUM. PARTE: 0986MN0804
MARCHA BOSCH
NISSAN TSURU III 1.6i 16V 1993-1995
NISSAN SENTRA 1.6i 1995-1999
NISSAN SENTRA 1.6i 16V 1996-2001
NISSAN LUCINO HATCH 1.6i 1996-2000



CLAVE: M10089
NUM. PARTE: 0986MN0801
MARCHA BOSCH
NISSAN TIIDA 1.8 2007-2010
NISSAN TIIDA 1.8 HATCHBACK 2007-2010
NISSAN SENTRA 1.8 2011-2014
NISSAN TIIDA 1.8 2010-2012



Marchas Sistema Bosch

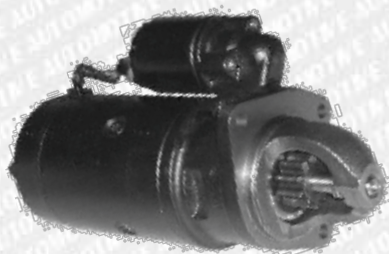

CLAVE: M40012
NUM. PARTE: 9000044001
MARCHA BOSCH PERKINS DERECHA
00001367017



CLAVE: M40009
NUM. PARTE: 9000044000
MARCHA BOSCH PERKINS BOSCH IZQ.
TODOS 9000143415

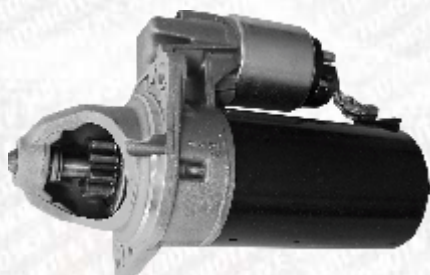

CLAVE: M50423
NUM. PARTE: 0001115042
MARCHA BOSCH
PMGR 1.4KW/12 VOLT
RUGGERINI
LOMBARDINI
HATZ 58402230



CLAVE: M70004
NUM. PARTE: 0001123007
MARCHA BOSCH NEW HOLLAND, FIAT 82980757
(97-...) 12V 3.0 KW ANTES
9007044015



CLAVE: M60120
NUM. PARTE: F000AL0100
MARCHA BOSCH FIAT PALIO S,
ADVENT 1.6LT 2003-2005 12V 1.1KW



Marchas Sistema Bosch

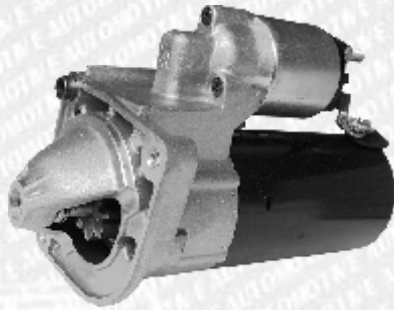

CLAVE: M50785
NUM. PARTE: 0001115078
MARCHA BOSCH
FIAT DUCATO 11 120 MULTIJET 2007-2014
FIAT DUCATO 15 120 MULTIJET 2007-2014
FIAT DUCATO 17 120 MULTIJET 2007-2014



CLAVE: M93022
NUM. PARTE: 0001109302
MARCHA BOSCH FIAT DUCATO 11 120
MULTIJET 2007-2014, FIAT DUCATO 15 120
MULTIJET 2007-2014, FIAT DUCATO 17 120
MULTIJET 2007-2014



CLAVE: M07088
NUM. PARTE: 0986MN0708
MARCHA BOSCH
FORD F-150 4.2L V6 1998-2010
FORD F-350 5.8l 1987-1991
FORD F-350 5.8l 1991-1997
FORD F-350 5.8 1979-1985



CLAVE: M07020
NUM. PARTE: 0986MN0702
MARCHA BOSCH FORD WINDSTAR 3.8 1996-2003,
FORD WINDSTAR 3.8 1994-1995

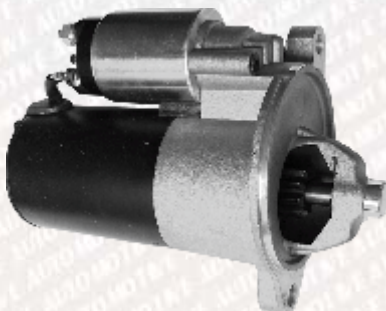

CLAVE: M07033
NUM. PARTE: 0986MN0703
MARCHA BOSCH
FORD F-150 4.2L V6 1998-2010
FORD F-350 5.8l 1987-1991
FORD F-350 5.8l 1991-1997
FORD F-350 5.8 1979-1985



Marchas Sistema Bosch

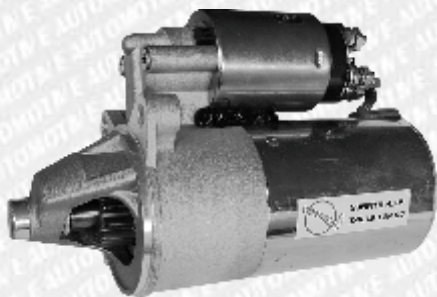

CLAVE: M533N4
NUM. PARTE: SR7533N
MARCHA BOSCH
FORD E-150 ECONOLINE 5.4l 1999-2002,
FORD E-150 ECONOLINE 5.4l 1998-1999,
FORD E-250 ECONOLINE 5.4l 1996-1999,
FORD E-350 ECONOLINE 5.4l 1996-1999



CLAVE: M30040
NUM. PARTE: 6004AA3004
MARCHA BOSCH FORD PICK UP STD,
MANUAL V8 12V 1.7KW
9007047001



CLAVE: M75489
NUM. PARTE: SR7548N
MARCHA BOSCH
FORD BRONCO 1981-1985

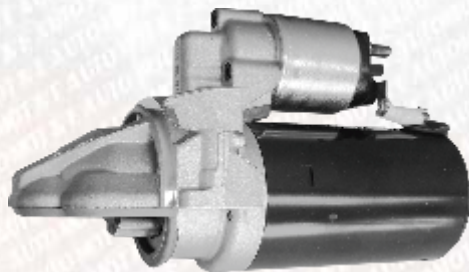

CLAVE: M93241
NUM. PARTE: 0001109324
MARCHA BOSCH
FORD TRANSIT FT 300 2.2 TDCI 2007-2010

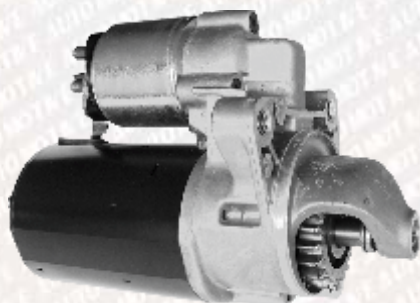

CLAVE: M70822
NUM. PARTE: 0001107082
MARCHA BOSCH
FORD FIESTA 1.3l 1998-2001



Marchas Sistema Bosch

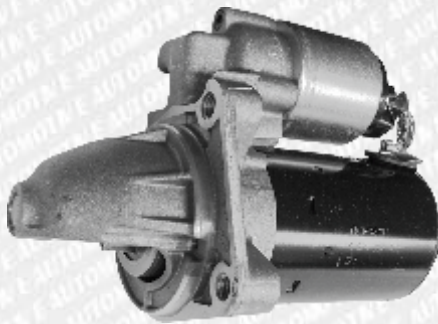

CLAVE: M74996
NUM. PARTE: 0001107499
MARCHA BOSCH
FORD FIESTA 1.6 TI-VCT 2010-2012
VOLVO C30 1.6 2010-2012



CLAVE: M07106
NUM. PARTE: 0986MN0710
MARCHA BOSCH
FORD FIESTA SEDAN 1.6I 2004-2010
FORD FIESTA 1.6I 2002-2007
FORD KA 1.6I 2001-2007
FORD FIESTA IKON 1.6I 2001-2004
FORD COURIER 1.6I 2000-2011
FORD FIESTA SEDAN 1.6I FIRST 2010-2014
FORD FIESTA 1.6I FIRST 2010-2014

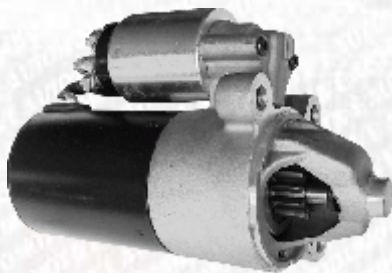

CLAVE: M07004
NUM. PARTE: 0986MN0700
MARCHA BOSCH
FORD FOCUS SVT 2.0 16V 1999-2005
FORD FOCUS 2.0I 16V 2003-2007

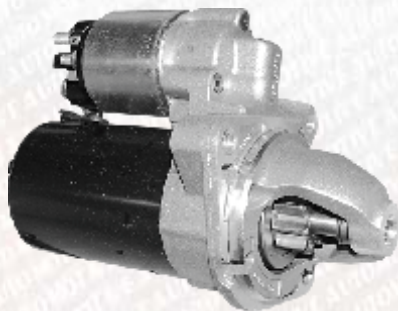

CLAVE: M74428
NUM. PARTE: 0001107442
MARCHA BOSCH 1.4KW 12V BMW SERIE 3 Y SERIE 5
CON MOTORES 2.0/2.4/2.5/2.8/3.0L (91-04)
BMW 728i, II (95-01) Z3 1.8/1.9/2/2.5/2.8/3L,
Z3 M 3.2L (95-02)
9 DIENTES CW
LESTER 17702 0001108157
BMW 124117-40374, -12937; 124143-54826

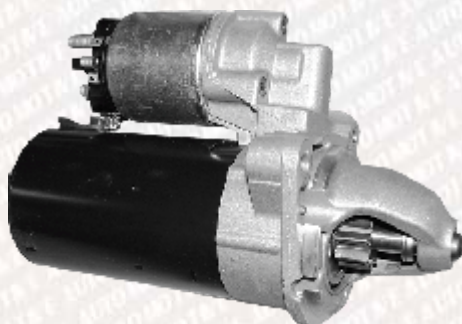

CLAVE: M82306
NUM. PARTE: 0001108230
MARCHA BOSCH 1.4KW 12V BMW X5 3L (01-06)
9 DIENTES CW
LESTER 17853 0001108-190,
230 BMW 124175-01668, -01738



Marchas Sistema Bosch

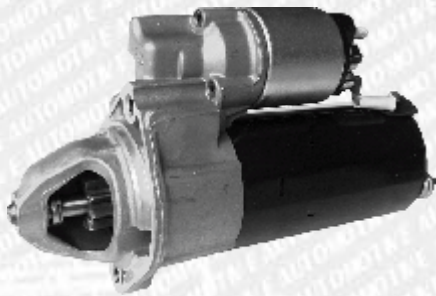

CLAVE: M00720
NUM. PARTE: 0001110072
MARCHA BOSCH
BMW X 5 4.4 i 2000-2003
BMW 540 i 1997-2003
BMW M 5 1998-2003
BMW 740 i,iL 1998-2001
BMW Z 8 2001-2003



CLAVE: M70759
NUM. PARTE: 0001417075
MARCHA BOSCH 6.6 KW 24V CAMIONES VOLVO FH12,
FM12 TRUCKS 12L, MOTORES DIESEL 12.0/12.1L,
AUTOBUS 7550 (98-03)
12 DIENTES CW
LESTER 18392 BOSCH 000141-7065,
7075 VOLVO 1547049, 3095060, 3964839, 811-3165, -3918

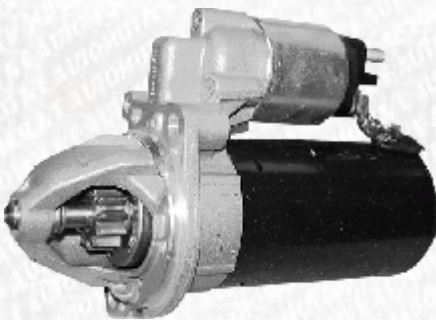

CLAVE: M50478
NUM. PARTE: 0001115047
MARCHA BOSCH 1.7KW 12V M BENZ E200/E220 2.1L (06 -..)
CLC200/CLC220 2.2L (08-..) CLK220 2.1L (05-..)
C200/C220 2.2L (03-..) SPRINTER 2.1L (06-..)R74-E25
12 DIENTES CW
LESTER 17883 BOSCH 0001115047
M BENZ 00615174-01, -0180; 00615125-01, -0180



CLAVE: M71007
NUM. PARTE: 0001371006
MARCHA BOSCH 371 SERIES DD CAMIONES
SCANIA SERIE 4
11 DIENTES CW
1357709



CLAVE: M83017
NUM. PARTE: 0001368301
MARCHA BOSCH
MARCHA EV(R) 24V 4.0 KW VOLVO (PN:0001231004)
VL6 E 62 (I) 7.1 2009
MARCHA IF(R) 24V 4.0KW SCANIA (PN:0001368301)
K 93 CL 91-01 L 94IB 99-14L 94UB 00-14 P 94/220 98-05
P,R 124/360 95-04, T 124/400 95-00
MARCHA MERCEDES-BENZ (PN:0001367303)
OF 1217 87-97



Marchas Sistema Bosch



CLAVE: M03276
NUM. PARTE: F000AL0327
MARCHA BOSCH
PEUGEOT 206 1.4i 2006-2009
PEUGEOT 206 1.6i 16V 2001-2007
PEUGEOT 206 CC 1.6i 16V 2002-2007
PEUGEOT 207 1.6i 16V 2008-2014
PEUGEOT GRAND RAID 1.6i 16V 2007-2008
PEUGEOT 206 1.6i 16V 2005-2007
PEUGEOT 206 1.4i 2005-2005
PEUGEOT 206 SW 1.6i 16V FLEX 2005-2008
PEUGEOT 206 SW 1.6i 16V 2004-2005



CLAVE: M09962
NUM. PARTE: 0986MN0996
MARCHA BOSCH
JEEP
LIBERTY 3.7 2001-2007
LIBERTY 3.7 4X4 2001-2007
LIBERTY 3.7 2007-2013
LIBERTY 3.7 4X4 2007-2013



CLAVE: M06246
NUM. PARTE: 0001106024
MARCHA BOSCH
RENAULT MEGANE II 2.0 2004-2009
RENAULT MEGANE 2.0i 16V 2000-2002
RENAULT MEGANE II 2.0 HATCHBACK SPORT 2003-2008
RENAULT MEGANE II 2.0 HATCHBACK 2004-2008
RENAULT CLIO II 2.0 16V SPORT 2002-2006
RENAULT SCENIC II 2.0 16V 2004-2009
RENAULT TRAFIC 2.0 2012-2014
RENAULT MEGANE II 2.0 CABRIO 2006-2009
RENAULT MEGANE II HATCHBACK 2.0 GT 2005-2008
RENAULT LAGUNA II 2.0 T 2006-2006
RENAULT LAGUNA II 2.0 T 2004-2005

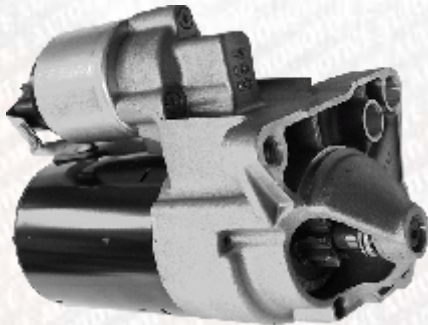

CLAVE: M06233
NUM. PARTE: 0001106023
MARCHA BOSCH
RENAULT TRAFIC 1.9 DCI 2008-2010
RENAULT TRAFIC II 1.9 DCI 2001-2006
RENAULT TRAFIC II 1.9 DCI 2001-2006

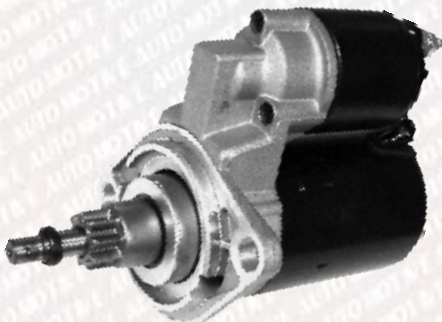

CLAVE: M31043
NUM. PARTE: 6004AA0031
MARCHA TIPO BOSCH 1.1KW 12V COMBI 1800
ENFRIADA POR AGUA (87-02)
9007042026



Marchas Sistema Bosch



CLAVE: M91232
NUM. PARTE: 02Z911023F
MARCHA TIPO BOSCH 1.7KW 12V EUROVAN TDI,
JETTA TDI 1.9/2.0L
11 DIENTES CCW
LESTER 32673, 32674 0001123012

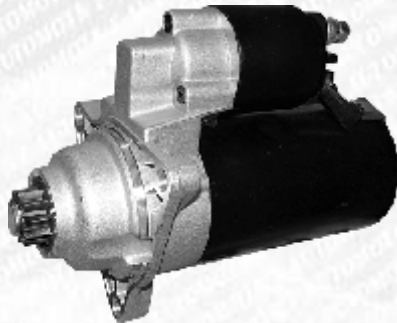

CLAVE: M91127
NUM. PARTE: 02B911023L
MARCHA SISTEMA BOSCH 2KW VW EUROVAN
GASOLINA 2.5/2.8L 5 CILINDROS (96-00)
10 DIENTES CCW
LESTER 17750

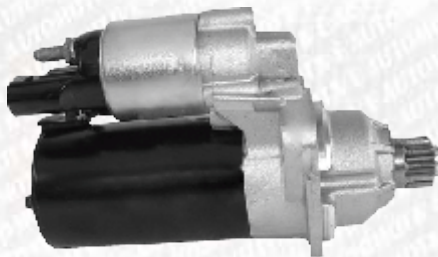

CLAVE: M79697
NUM. PARTE: 17969N
MARCHA IMPORTACION
SISTEMA BOSCH PMGR 12V. AUDI 2012,
VOLKSWAGEN 05-12 AUDIVW
02M-911-023S, 02M-911-023SX,
BOSCH 0-001-122-402, 0-001-122-403
10 DIENTES



CLAVE: M60044
NUM. PARTE: 6004AA2005
MARCHA TIPO BOSCH NISSAN PICK UP D-21 93-2005
9007046004, 6004AA2004, 23300-F4000 **M23401**



CLAVE: M82512
NUM. PARTE: 18251N
MARCHA NUEVA SISTEMA BOSCH
VOLVO 24 VOLT. EXCAVADORAS,
RETROESCAVADORAS
(MANO DE CHANGO)
SM2514



Marchas Sistema Bosch



CLAVE: M89495
NUM. PARTE: 18949N
MARCHA BOSCH PMGR 12V.
JUNGHEINRICH 00, PERKINS 00
BOSCH 0-001-109-035
9 DIENTES



CLAVE: M70949
NUM. PARTE: 17094N
MARCHA BOSCH
416 SERIES DD 5.4KW/24 VOLT,
ATLAS, DEUTZ, IVECO, KHD, DEUTZ
MOTORES MARINOS 50-9115
11 DIENTES CW



CLAVE: M18231
NUM. PARTE: 18230
MARCHA SISTEMA BOSCH PLGR 12V
DEUTZ 95-07 , KHD 95-07 , SCHWING 97-03 ,
THOMAS EQUIPMENT 97-00 2.2KW
11 DIENTES



CLAVE: M32236
NUM. PARTE: 33223N
MARCHA SISTEMA BOSCH PLGR 2.5KW 12V
FIAT DUCATO 11 2300 05-08
DUCATO 15 2300 05-08
DUCATO 18 2800 05-08
DUCATO MAXI 18 2300 05-08
DUCATO MAXI 18 2800 05-08
0001109300, 0001109301, 1347058080.
9 DIENTES



CLAVE: M29717
NUM. PARTE: 0001371006
MARCHA SISTEMA BOSCH
SERIE 371 DD 24V 6.7KW SCANIA TRUCK
1357709 M2971 2-2631-BO **A29711**
11 DIENTES



Marchas Sistema Bosch

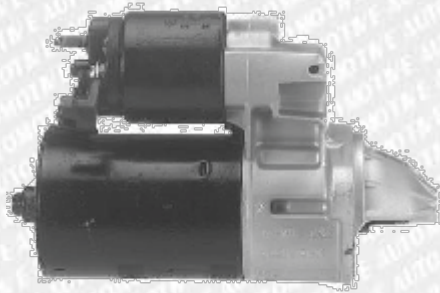

CLAVE: M16818
NUM. PARTE: 2-1681-BO
MARCHA SISTEMA BOSCH PMGR 1.1KW 12V
DODGE NEON 96-97 L4 2L, STRATUS 96-97 L4 2L,
PLYMOUTH NEON 96-97 L4 2L
8 DIENTES CW
LESTER 17572
4793210 M21009
0-001107049 9007045020



CLAVE: M78125
NUM. PARTE: 17812N
MARCHA BOSCH PMGR 1.1KW/12 VOLT,
NISSAN SENTRA 1.8L 2002,
NISSAN SENTRA 2.0L 01-02
2-2657-MI
8 DIENTES CW

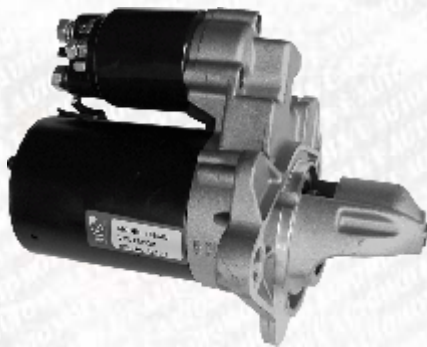

CLAVE: M78547
NUM. PARTE: 17854N
MARCHA BOSCH PMGR 0.9KW/12 VOLT,
MINI COOPER 1.6L 02-09
2-2557BO
9 DIENTES CW

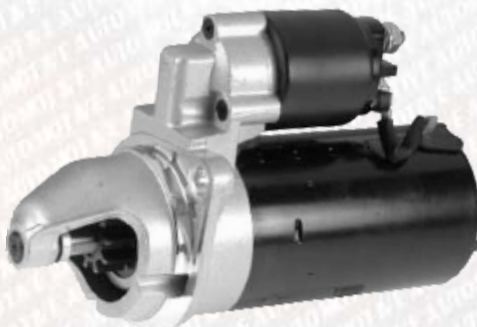

CLAVE: M83690
NUM. PARTE: 18369N
MARCHA IMPORTACION BOSCH PLGR MERCEDES
RUGGERINI, LOMBARDINI, HATZ
9 DIENTES CCW

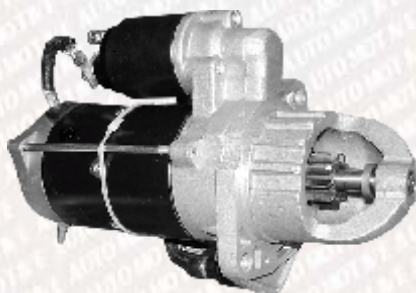

CLAVE: M28039
NUM. PARTE: 0001231033
MARCHA NUEVA SISTEMA BOSCH PLGR MERCEDES
BENZ 24V ALEGRO, MARCO POLO
HE95-M 4.0KW 0001231002 SM2803
9 DIENTES CW
LESTER 18364



Marchas Sistema Bosch



CLAVE: M29733
NUM. PARTE: 0001372005
MARCHA SISTEMA BOSCH DD MERCEDES BENZ 24V 6.2 KW
EO 4571510301 M-BENZ O345 OM 457.942, O530 GN3 OM
457.932-935, O530 GNUE3 OM 457.933-935,
O 530 N3 OM 457.933-935/942 SM2973
11 DIENTES CW
LESTER 30114

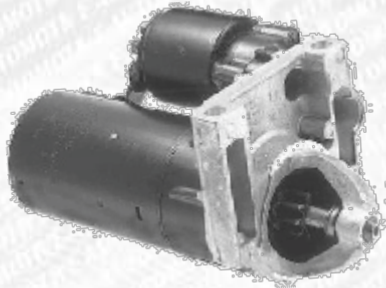

CLAVE: M12318
NUM. PARTE: 2-1231-BO
MARCHA SISTEMA BOSCH PMGR 1.4 KW 12V JEEP
CHEROKEE 86-94 L4 2.5L; COMANCHE 86-92 L4 2.5L;
WAGONEER 86-90 L4 2.5L; WRANGLER 87-94 L4 2.5L
56027350 001108154
9 DIENTES CW
LESTER 16980

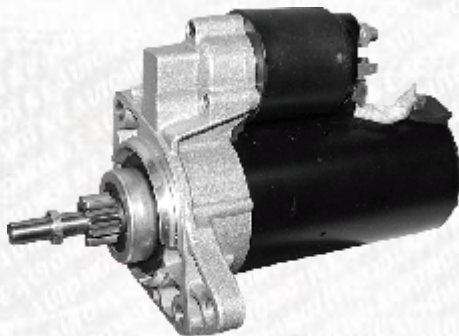

CLAVE: M13658
NUM. PARTE: 2-1365-BO
MARCHA SISTEMA BOSCH PLGR 1.7 KW, 12 V CORRADO
V6 2.8LTS 92-94, EUROVAN L5 2.5L 93-95, EUROVAN V6 2.8L 2003
GOLF L4 1.6L 85-88, GOLF V6 2.8L 1995, JETTA L4 1.6L 84-92,
JETTA V6 2.8L 94-95, PASSAT V6 2.8L 93-96,
PASSAT L4 1.9L 1996, CARIBE L4 1.6L 1984.
9 DIENTES CCW
LESTER 17030

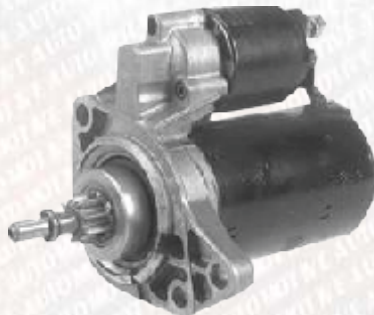

CLAVE: M70629
NUM. PARTE: 2-1372-BO
MARCHA SISTEMA BOSCH PMDD 1.0 KW, 12 V
CABRIOLET L4 1.8L 88-93, CORRADO L4 1.8L 1990,
GOLF L4 1.8L 89-91, JETTA L4 1.8L 87-90.
9 DIENTES CCW
LESTER 17062
0001114005



CLAVE: M13733
NUM. PARTE: 2-1373-BO
MARCHA SISTEMA BOSCH PMGR 1.1 - 1.4 KW 12V
VW GOLF 92-96 L4 1.8L Y 2L, JETTA 90-96 L4 2L,
PASSAT 90-91 L4 2L
9 DIENTES CCW
LESTER 17222
0001108005



Marchas Sistema Bosch

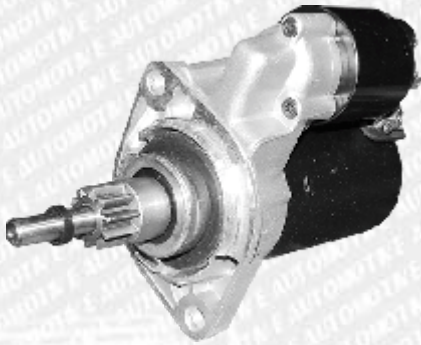

CLAVE: M13746
NUM. PARTE: 2-1374-BO
MARCHA SISTEMA BOSCH PMGR 1.4KW 12V GOLF 90-92 L4 2L;
JETTA 90 L4 2L; PASSAT 90-91 L4 2L
10 DIENTES CCW
LESTER 17223
0-986-016-110
001107003

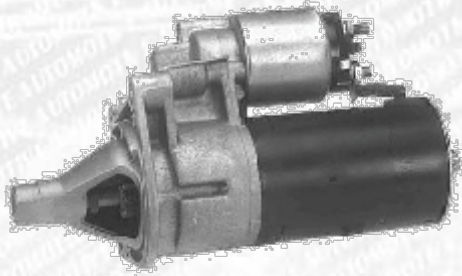

CLAVE: M72101
NUM. PARTE: 2-1394-BO
MARCHA DODGE BOSCH PMGR 1.4KW, 12 V
LEBARON V6 3L 90-95, NEW YORKER V6 3L 1990,
CARAVAN V6 3L 90-93, SHADOW V6 3L 93-94,
SPIRIT V6 3L 90-95, VOYAGER V6 3L 90-93.
9 DIENTES CW
LESTER 17210
DELCO 336-1539



CLAVE: M69624
NUM. PARTE: 2-1385-BO
MARCHA NUEVA DODGE BOSCH PMGR 1.4KW, 12 V
LEBARON L4 2.5L 91-93, NEW YORKER L4 2.5L 91-95,
NEW YORKER L4 2.2L 88, CARAVAN L4 2.5L 1987-1995,
SHADOW L4 2.2L 87-94, SPIRIT L4 2.5L 89-95,
VOYAGER L4 2.2L 86-87, VOYAGER L4 2.5L 88-95;
DAKOTA 91-96 L4 2.5L; DAYTONA 91-93 L4 2.2L, 2.5L;
DINASTY 88-93 4CIL 2.5L.
9 DIENTES CW
LESTER 16962 16963
4557130 001108103

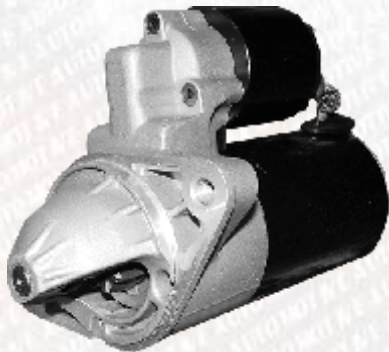

CLAVE: M15198
NUM. PARTE: 2-1519-BO
MARCHA SISTEMA BOSCH PMGR 1.1KW 12V
CHRYSLER SEBRING 95-99 L4 2L; DODGE AVENGER 95-99
L4 2L; MITSUBISHI ECLIPSE 95-99 L4 2L.
8 DIENTES CW
LESTER 17563
4672108 001107032



CLAVE: M15320
NUM. PARTE: 2-1532-BO
MARCHA SISTEMA BOSCH PMGR 1.1 KW 12V
VW BEETLE 98 L4 2L, JETTA 2000 L4 1.8L,
PASSAT 92-93, 96 L4 2L
10 DIENTES CCW
LESTER 17416



Marchas Sistema Bosch

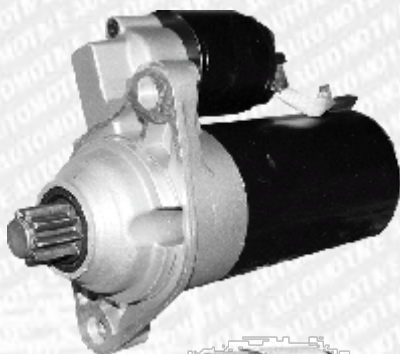

CLAVE: M15359
NUM. PARTE: 2-1535-BO
MARCHA SISTEMA BOSCH PMGR 1.7KW 12V
GOLF 95-99 V6 2.8L; JETTA 94-99 2.8L, PASSAT 93-97 V6 2.8L.
BENDIX FLOTANTE
10 DIENTES CCW
LESTER 17417
0001125009 0-986-019-550
0001125039



CLAVE: M74077
NUM. PARTE: 2-1536-BO
MARCHA SISTEMA BOSCH PMGR 1.4 KW, 12 V VOLKSWAGEN
PASSAT V6 2.8 LTS 1998-1999, AUDI SERIES 100 V6 2.8LTS
1992-1994, AUDI SERIES 90 V6 2.8LTS 1992-1995,
AUDI A4 V6 2.8LTS 1996-2000, AUDI A6 V6 2.8LTS 1995-1997,
AUDI CABRIO V6 2.8 LTS 1994-1998.
9 DIENTES CW
LESTER 17407

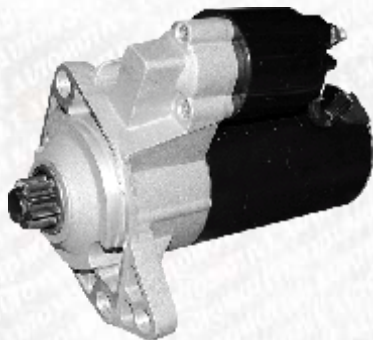

CLAVE: M77253
NUM. PARTE: 2-1904-BO
MARCHA SISTEMA BOSCH PMGR 1.8KW 12V BEETLE,
GOLF L4 1.9L 98-03, GOLF V6 2.8L 96-99,
JETTA A-4 L4 1.9L 99-03, AUTOMATICO 1.8/2.0L 1.8T 99-03
9 DIENTES CCW
LESTER 17725

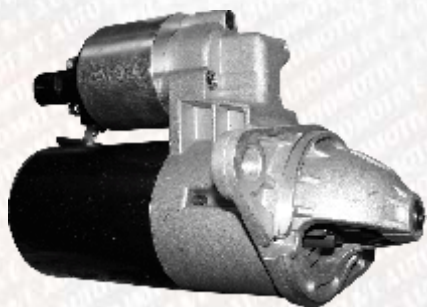

CLAVE: M19377
NUM. PARTE: 2-1937-BO
MARCHA SISTEMA BOSCH PMGR 1.1KW 12V CHRYSLER
CIRRUS L4 2L, DODGE NEON 98-99 L4 2L,
STRATUS 98-2000 L4 2L, PLYMOUTH NEON 98-99 L4 2L
8 DIENTES CW
LESTER 17736
6004AA0018

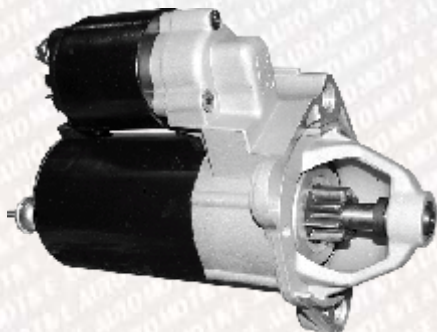

CLAVE: M19453
NUM. PARTE: 2-1945-BO
MARCHA SISTEMA BOSCH PMGR 1.1 KW 12V
AUDI A-4 97-00 1.8L L4; PASSAT 98 L4 1.8L
9 DIENTES CW
LESTER 17751
0-986-016-330
0001107068



Marchas Sistema Bosch



CLAVE: M19744

NUM. PARTE: 2-1974-BO

MARCHA SISTEMA BOSCH PMGR 12V 2.0KW VW BEETLE 98-2001 L4 1.9L, GOLF 99-2003 L4 1.9L, JETTA 99-2002 L4 1.9L

10 DIENTES CCW

LESTER 17755



CLAVE: M19757

NUM. PARTE: 2-1975-BO

MARCHA SISTEMA BOSCH 1.1 KW 12V AUDI TT 2000-2004 L4 1.8L, VW BEETLE 98-2003 L4 2L, L4 1.8L, GOLF 2000-2003 L4 1.8L, L4 2L, JETTA 2000-2003 L4 1.8L, L4 2L

10 DIENTES CCW

LESTER 17780

001121008



CLAVE: M30475

NUM. PARTE: 2-3047-BO

MARCHA NUEVA SISTEMA BOSCH PMGR 12V 1.1KW AUDI A2 1.4L 99-02, SEAT IBIZA 1.2L 01-02, VOLKSWAGEN BORA 1.6L FSI 01-02, GOLF A4 1.6L 01-ON, LUPO 1.6L 16V 00-02, POLO 1.2L 01-04, POLO 1.4L 01-ON

LESTER 31220N

10 DIENTES

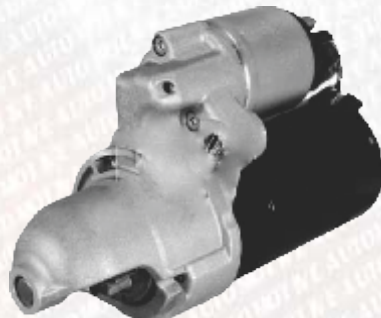

CLAVE: M79769

NUM. PARTE: 17976N

MARCHA NUEVA SISTEMA BOSCH 1.2KW/12 VOLT, AUDI A4 3.2L, 06-08, AUDI A6 3.2L 05-08 BOSCH 0-001-108-405, -406

10 DIENTES

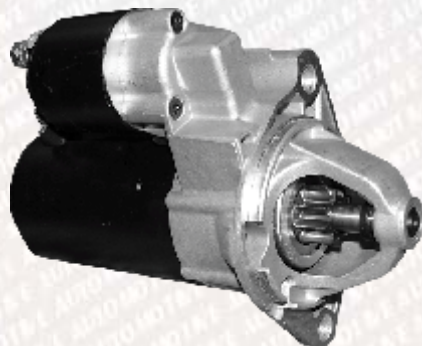

CLAVE: M19888

NUM. PARTE: 2-1988-BO

MARCHA SISTEMA BOSCH PLGR 12V 1.6KW ISUZU AMIGO L4 2.2L 98-00; RODEO 2.2L L4 99-02.

9 DIENTES CW

LESTER 17770

DELCO 336-1707 N

F005M00001 92064181 8920641810



Marchas Sistema Bosch

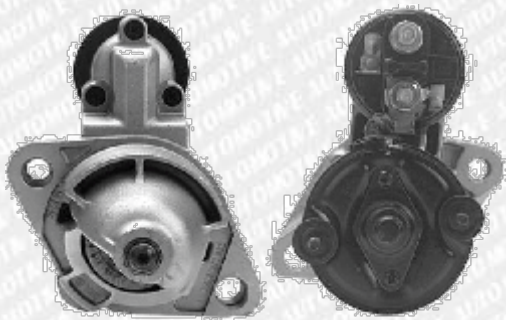

CLAVE: M77789
NUM. PARTE: 2-2084-B0
MARCHA SISTEMA BOSCH 1.4 KW 12V PMGR
AUDI A4 99-2004 V6 2.8L Y 3L,
AUDI A6 98-2004 V6 2.8L , 2.7L Y 3L,
AUDI S4 2000-2002 V6 2.7L
PASSAT 2000-2003 V6 2.8L
9 DIENTES CW
LESTER 17778



CLAVE: M25436
NUM. PARTE: 2-2085-BO
MARCHA SISTEMA BOSCH DD 3.1KW 12V
FORD TRACTOR
0001369023
10 DIENTES CW 3 OREJAS
LESTER 18024
M2543



CLAVE: M09026
NUM. PARTE: 0986MN0902
MARCHA BOSCH
HONDA
ACURA TSX 2.4 2008-2014
CR-V 2.4i 2006-2007
CR-V 2.4 4X4 2012-2014
CR-V 2.4 4X4 2009-2014
ACCORD 2.4 2007-2014
ACCORD 2.4 2007-2009
CIVIC 2.4 COUPE 2011-2014

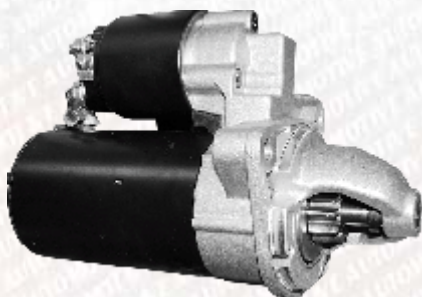

CLAVE: M19976
NUM. PARTE: 2-1997-BO
MARCHA SISTEMA BOSCH 1.4 KW 12V PMGR
BMW 318 96-99 L4 1.9L
BMW 323 98-2000 L6 2.5L
BMW 325 2001-2003 L6 2.5L
BMW 328 96-2000 L6 2.8L
BMW 330 2001-2003 L6 3L
BMW 525 2001-2003 L6 2.5L
BMW 528 97-2003 L6 3L
BMW Z3 96-2002 L4 1.9L, L6 2.8L, 2.5L, 3.2L, Y 3L
9 DIENTES CW
LESTER 17702

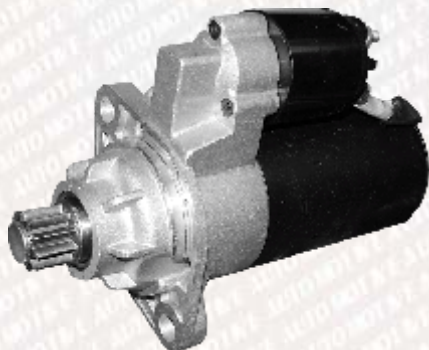

CLAVE: M23414
NUM. PARTE: 2-2341-BO
MARCHA SISTEMA BOSCH PMGR 2.0KW 12V VW
SHARAN 01-05
SEAT ALHAMBRA 01-05
10 DIENTES CCW
LESTER 17820
CAMPANA 2 OREJAS
0001125018
0-986-018-390
0001125048



Marchas Sistema Bosch



CLAVE: M23558
NUM. PARTE: 2-2355-BO
MARCHA SISTEMA BOSCH PMGR 12V 2.2KW DODGE
SPRINTER VAN 04-06 L5 2.7L; MERCEDES E CLASS
05-06 L6 3.2L MERCEDES BENZ Sprinter 316
CDI 2.7L (04-06) 0051516601
11 DIENTES CW
LESTER 18360
0001109250 0986017260



CLAVE: M30079
NUM. PARTE: 2-3007-BO
MARCHA SISTEMA BOSCH SERIES 223 PLGR 2.3KW 12V
9 DIENTES CW
LESTER 18951
0001223016
118-1751



CLAVE: M31186
NUM. PARTE: 2-3118-BO
MARCHA SISTEMA BOSCH DD 4KW 24V 9000083064
MERCEDES BENZ 1985 MODELO 366
MOTOR OM-366A 6L
9 DIENTES CW
LESTER 18250
N 343-151-72-01



CLAVE: M67501
NUM. PARTE: 0-986-016-750
MARCHA SISTEMA BOSCH PMGR 12V
AUDI, V.W. 91-2005 001107005
10 DIENTES CCW
LESTER 33031



CLAVE: M10237
NUM. PARTE: 020911023K
MARCHA SISTEMA BOSCH PMGR 12V VW
GOLF A2 STANDARD 87-92
JETTA A2 STANDARD 87-92
9 DIENTES CCW
LESTER 17222
6004AA0019



Marchas Sistema Bosch

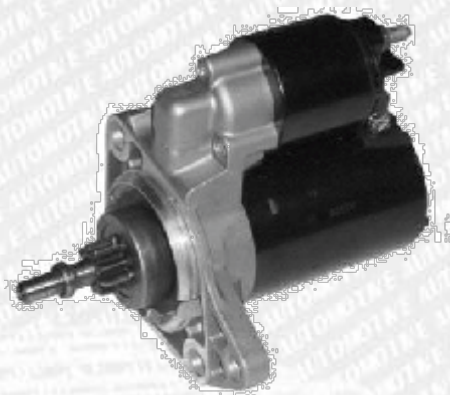

CLAVE: M91101
NUM. PARTE: 1GD911023B
MARCHA SISTEMA BOSCH PMGR STD
Y AUTOMATICO (93-99) 1.1KW 12V
VW CABRIO 95-2001 L4 2L,
GOLF 97-99 L4 2L,
JETTA 97-99 L4 2L, 2003 L4 1.9L,
PASSAT 92-93 L4 2L , 96 L4 2L. 2-1534-B0
9 DIENTES CCW
LESTER 17415
0-986-016-290
001107020



CLAVE: M02101
NUM. PARTE: 6004AA0021
MARCHA SISTEMA BOSCH V.W. 1600
9007042025
9007042024
BAA911023B



CLAVE: M16029
NUM. PARTE: 0001416002
MARCHA SISTEMA BOSCH KB (R) DD 24V 5.4KW
MERCEDES BENZ MOTOR OM-401, 422,441,442;
MASSEY FERGUSON #OE
0031514101
0031514501
741031000
0041516001 50-9117
9 DIENTES CW
LESTER 18113



CLAVE: M25233
NUM. PARTE: 2523
MARCHA IMPORTACION T/BOSCH
PERKINS BOSCH IZQ.
9000143415
9000044000
JST3401

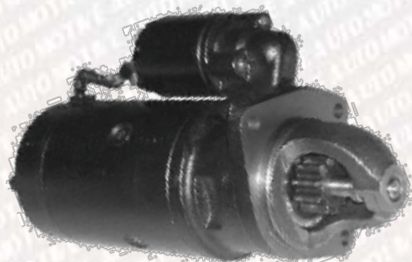

CLAVE: M25259
NUM. PARTE: 2525
MARCHA IMPORTACION T/BOSCH
PERKINS BOSCH DER
9000044001
0001367017



Marchas Sistema Bosch

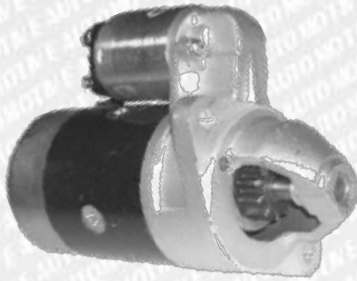

CLAVE: M25335
NUM. PARTE: 2533
MARCHA IMPORTACION T/BOSCH
MERCEDES BENZ 12V
9 DIENTES
9007044011
0001367303
17106 50-9100



CLAVE: M91055
NUM. PARTE: 50-9105
MARCHA SISTEMA BOSCH DD 3.0KW 12V
FORD,
NEW HOLLAND
IVECO
9 DIENTES CW
LESTER 17092
0001367029
17092 M2537



CLAVE: M33049
NUM. PARTE: JST3304
MARCHA TIPO BOSCH DD
MERCEDES BENZ 12V
10 DIENTES CW
LESTER 17309
9000083071



CLAVE: M91245
NUM. PARTE: 50-9124
MARCHA SISTEMA BOSCH DD 2.7KW 12 V
ATLAS COPCO
CLAAS
DEUTZ TRACTOR
DEUTZ-FAHR
IHC
IVECO TRUCKS
KHD
LIEBHERR
9 DIENTES CW
LESTER 17075
0001358046



CLAVE: M09102
NUM. PARTE: 40-0910
MARCHA IMPORTACION SISTEMA
BOSCH POINTER 1.8 Y 2.0 LT 98-2005
9000081006



Marchas Sistema Bosch

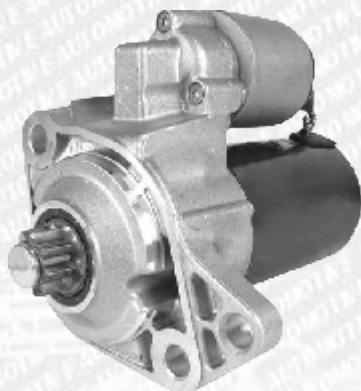

CLAVE: M77810
NUM. PARTE: 2-2116-BO
MARCHA SISTEMA BOSCH PMGR 1.1 KW 12V VW
BEETLE 98-2003 L4 1.8L Y 2L.
GOLF 99-2002 L4 1.8L, L4 2L.
JETTA 2000-2003 L4 1.8L, L4 2L.
9 DIENTES CCW
LESTER 17781
0001121006



CLAVE: M06056
NUM. PARTE: 0986MN0605
MARCHA BOSCH
CHRYSLER
STRATUS 2.4i 16V 1995-2001,
STRATUS 2.0i 16V 1995-2001,
STRATUS 2.4i TURBO 1994-2000,
PT CRUISER 2.4 2000-2010,
CIRRUS 2.5i 24V 1996-2000,
CIRRUS CONVERTIBLE 2.4 R/T 1997-2000,
CIRRUS 2.4 COUPE 1997-2000,
PT CRUISER 2.4 2008-2010,
CIRRUS 2.5 COUPE 1998-2000,
DODGE
NEON 2.0 1999-2005
STRATUS 2.4 2001-2006
STRATUS 2.0i 16V 2000-2006
PLYMOUTH
BREEZE 2.0i 16V 1995-2000



CLAVE: M08094
NUM. PARTE: 0986MN0809
MARCHA BOSCH
NISSAN
X-TRAIL 2.5 4X4 2002-2007
SENTRA 2.5 2001-2006
X-TRAIL 2.5 2001-2007
X-TRAIL 2.5 4X4 2007-2014
X-TRAIL 2.5 2007-2014
URVAN 2.5i 2008-2012
ALTIMA 2.5 2001-2006
ROGUE 2.5 2007-2014
ROGUE 2.5 4X4 2007-2014
ALTIMA 2.5 2006-2012
SENTRA 2.5 SE-R B16 2007-2012



CLAVE: M09013
NUM. PARTE: 0986MN0901
MARCHA BOSCH
HONDA
ACCORD 3.0 1997-2002
HONDA ODYSSEY 3.5 2001-2004
ACCORD 3.0i 24V 2003-2007
PILOT 3.5i 4WD 2002-2004
ACCORD 3.0i COUPE 2002-2005



MARCHAS SISTEMA
DELCO



Marchas Sistema Delco

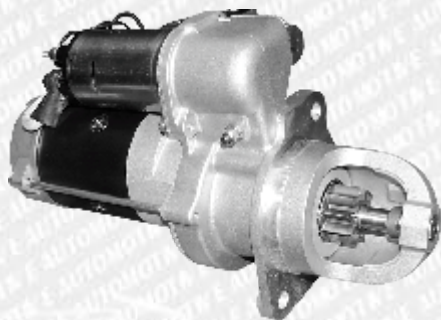

CLAVE: M96370
NUM. PARTE: 10479637
MARCHA DELCO REMY 3KW 12V 28MT 12V
CON RELAY MB ECOPOWER, FREIGHTLINER
9 DIENTES CW
LESTER 6604, 6610 DELCO 104614-54, -76;
104796-37, -45, -48 M BENZ (A)0051511201



CLAVE: M32762
NUM. PARTE: 1113276
MARCHA DELCO REMY 28MT 12V FORD E-SERIES
VAN (83-84) F-SERIES PICKUP 6.9L,
FREIGHTLINER, KENWORTH, STERLING,
CUMMINS 3.9L, MOTORES DIESEL 5.9L
10 DIENTES CW
LESTER 3300, 4391, 6573, 6869



CLAVE: M96456
NUM. PARTE: 10479645
MARCHA DELCO REMY 3KW 12V 28MT MB ECOPOWER,
FREIGHTLINER, CAMIONES STERLING MEDIUM/HEAVY DUTY
9 DIENTES CW
LESTER 6604, 6610

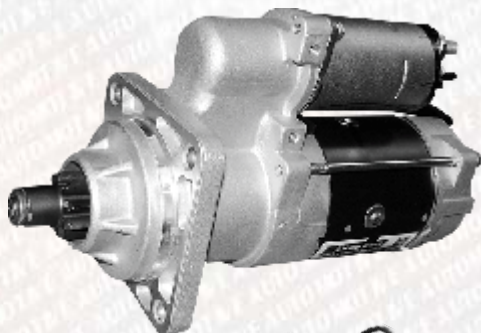

CLAVE: M11404
NUM. PARTE: 19011403
MARCHA DELCO REMY 29MT 12V ECOPOWER 904, 906,
FREIGHTLINER CON MOTOR MERCEDES
9 DIENTES CW
LESTER 6842 DELCO 8200(011), (103), 10461772

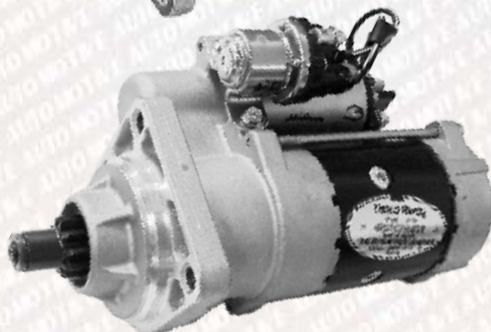

CLAVE: M04780
NUM. PARTE: 8200478
MARCHA DELCO REMY 29MT 12V VW WORKER
10 DIENTES CW



Marchas Sistema Delco

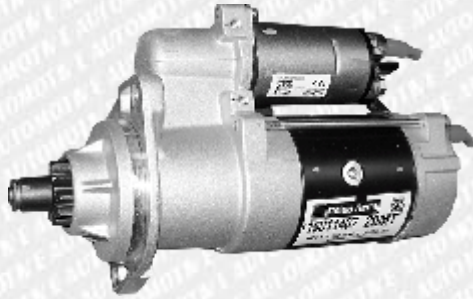

CLAVE: M90403
NUM. PARTE: 19011407P
MARCHA DELCO REMY 29MT 12V AUTOBUSES
INTERNACIONALES Y CAMIONES CON MOTOR
DE DIESEL IHC VT-365 6L
10 DIENTES
LESTER 6843 DELCO 10461764, 19011-404, -407

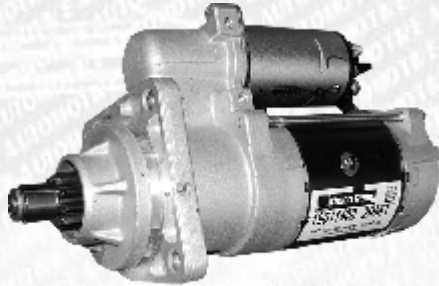

CLAVE: M14007
NUM. PARTE: 19011400
MARCHA DELCO REMY 29MT 12V FREIGHTLINER
CON MOTOR ISB CUMMINS
10 DIENTES CW
LESTER 6840 DELCO 8200010, 10461770, 19011400



CLAVE: M00293
NUM. PARTE: 8200297
MARCHA DELCO REMY 29MT 24V
M BENZ
11 DIENTES CW



CLAVE: M02961
NUM. PARTE: 8200296
MARCHA DELCO REMY 29MT 24V M BENZ ALLEGRO
11 DIENTES CW

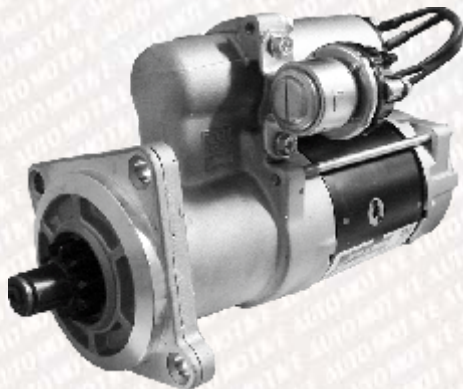

CLAVE: M03263
NUM. PARTE: 8200326P
MARCHA **DELCO REMY** 29MT 12V 10DTS. MOD 3,
IMS P/ INTERNATIONAL URBANO MOTOR MWM 4.8L
4CIL SAE1 EURO III rempaza M93R 352 597 60,
MWM 905720100111; N/P 8200849



Marchas Sistema Delco



CLAVE: M20140
NUM. PARTE: 19011402P
MARCHA DELCO REMY 29MT 12V 10 DIENTES
3.3KW PLGR F600 / F700 / F800 / F900 CUMMINS
5.9L 92-99. FREIGHTLINER



CLAVE: M39691
NUM. PARTE: 1993969
MARCHA DELCO REMY 37MT 12V STERLING CON
CUMMINS 8.9L
12 DIENTES CW
LESTER 6400, 6613



CLAVE: M61719
NUM. PARTE: 10461719
MARCHA DELCO REMY 37MT 12V
12 DIENTES

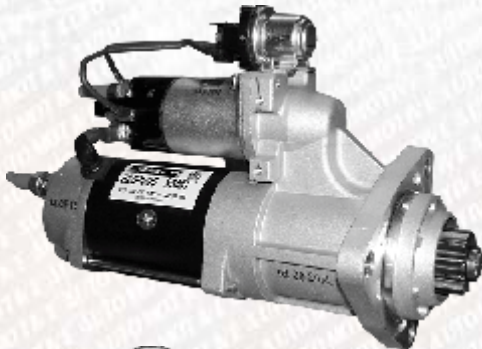

CLAVE: M00058
NUM. PARTE: 8200005
MARCHA DELCO REMY 38MT 12V FREIGHTLINER,
CUMMINS ISC, ISL 8.3L, INTERNATIONAL DT 466 7.6L
12 DIENTES CW
LESTER 6808 DELCO -82, -8300005,
19026029



CLAVE: M02898
NUM. PARTE: 8200289
MARCHA DELCO REMY 39MT 12V FREIGHTLINER,
INTERNATIONAL, CAMION VOLVO CON CATERPILLAR
C10, 11, 12, 13, 15; CUMMINS MOTOR ISX
11 DIENTES CW
LESTER 68(04), (06), (22), (24), (25), 6911
DELCO 8200-050, -090, -104, -290



Marchas Sistema Delco



CLAVE: M82027
NUM. PARTE: 8200290
MARCHA DELCO REMY 39MT 12V KENWORTH,
PETERBILT CON CATERPILLAR C9, 10, 11, 12, 15,
CUMMINS ISM, MOTORES DIESEL ISX
11 DIENTES CW
LESTER 6856, 6912
DELCO 82000-50, -90; 8200-104, -290



CLAVE: M11518
NUM. PARTE: 19011518
MARCHA DELCO REMY 39MT 12V
11 DIENTES CW
LESTER 6804, 6806
DELCO 82000-33, -40; 10461-753, -777; 19011-506, -516, -518



CLAVE: M82085
NUM. PARTE: 8200308
MARCHA DELCO REMY 39MT 12V
11 DIENTES 6924N



CLAVE: M33403
NUM. PARTE: 8200433P
MARCHA DELCO REMY 39 MT 12V
12 DIENTES
LESTER 6907N



CLAVE: M03218
NUM. PARTE: 8200321
MARCHA DELCO REMY 39MT 24V CON
PROTECCION TERMICA
11 DIENTES CW



Marchas Sistema Delco



CLAVE: M03307
NUM. PARTE: 8200330P
MARCHA DELCO REMY 39MT 24V
11 DIENTES



CLAVE: M92834
NUM. PARTE: 10479283
MARCHA DELCO REMY 41MT 12V
MERCEDES BENZ REPARTO
11 DIENTES



CLAVE: M89993
NUM. PARTE: 10478999
MARCHA DELCO REMY 41MT 12V KENWORTH,
PETERBILT, STERLING CON CUMMINS 8.9L ISC,
MOTORES ISL
12 DIENTES CW
LESTER 6400, 6613
DELCO 1993969, 10478999, 104611-69, -71



CLAVE: M92922
NUM. PARTE: 10479292
MARCHA DELCO REMY 41MT 24V OM 457
MERCEDES-BENZ 1938L/1944L/2638LK/O-400
12 DIENTES CW

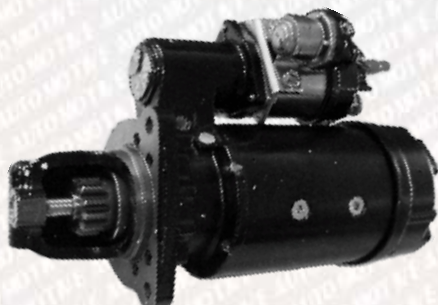

CLAVE: M93107
NUM. PARTE: 10479310
MARCHA DELCO REMY 41MT 24V OM 457
MERCEDES-BENZ 1938L/1944L/2638LK/O-400
12 DIENTES CW



Marchas Sistema Delco



CLAVE: M88127
NUM. PARTE: 10478812
MARCHA DELCO REMY 41MT 12V
12 DIENTES 6617



CLAVE: M04836
NUM. PARTE: 1990483
MARCHA DELCO REMY 42MT 12V
11 DIENTES CW
LESTER 6356



CLAVE: M04894
NUM. PARTE: 1990489
MARCHA DELCO REMY 42MT 12V FREIGHTLINER,
IHC, KENWORTH, PETERBILT, STERLING,
CAMIONES VOLVO, WESTERN STAR
11 DIENTES CW
LESTER 6554 DELCO 1990489,
104610-62, -75; 1047-9080, -9105



CLAVE: M04909
NUM. PARTE: 1990490
MARCHA DELCO REMY 42MT 12V FREIGHTLINER,
KENWORTH, PETERBILT, STERLING, CAMIONES VOLVO,
WESTERN STAR CON MOTOR CUMMINS O CATERPILLAR
11 DIENTES CW
LESTER 6511 DELCO 1990490, 10479104, 104610-42, -53

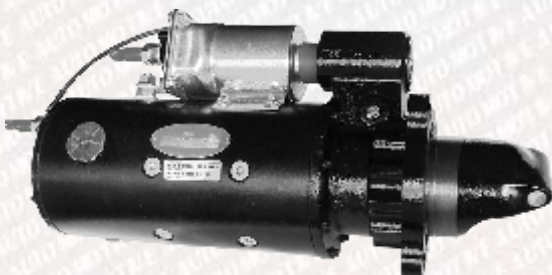

CLAVE: M93397
NUM. PARTE: 10479339P
MARCHA DELCO REMY 50MT 24V
11 DIENTES



Marchas Sistema Delco

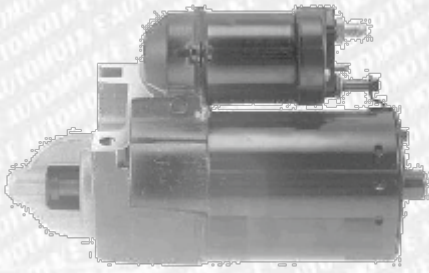

CLAVE: M15169

NUM. PARTE: 2-1516-DR

MARCHA DELCO 5MT SD250 12V BUICK CENTURY 3.3/3.8L

(86-93) OLDSMOBILE SILHOUETTE 3.8L (92-95)

PONTIAC TRANS SPORT 3.4L (92-95) BONNEVILLE 3.8L (87-95)

GRAND AM 3.0/3.3L (86-93) LUMINA APV VAN 3.8L (92-95)

DELCO 1998-518, -521, -544, -545;

10455-006, -024, -706

LESTER 6339

9 DIENTES CW



CLAVE: M16045

NUM. PARTE: 2-1604-DR

MARCHA DELCO SD300 10MT CHEVROLET/GMC 4.3L (85-90)

5.0L/7.4L (82-94) BUICK/CADILLAC/CHEVROLET/GMC 5.7L (81-94)

V8 BLAZER 5.7L (84-92) CK SERIES PICK UP 5.7L (82-94)

G SERIES VAN 5.7L (82-94) 5L SUBURBAN 5.7L (82-94) 7.4L

9 DIENTES CW

LESTER 3510M

DELCO 1998584, 10455305, 10496873

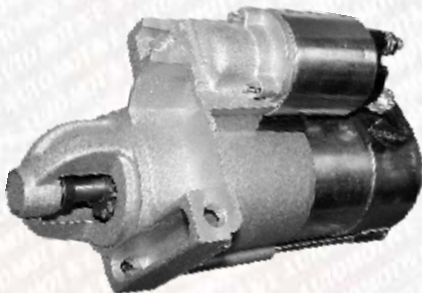

CLAVE: M16889

NUM. PARTE: 2-1688-DR

MARCHA DELCO PG260M 12V CAMARO 3.8L (95-97)

LUMINA/MONTE CARLO 3.4L (96-97)

CUTLASS 3.4L (1996) CON MOTOR SUPERCARGADO:

BUICK PARK AVENUE 3.8L (91-01) REGAL 3.8L (97-01)

OLDSMOBILE 3.8L 88 (95-99) 98 (92-95) CUTLASS 3.4L (1996)

PONTIAC BONEVILLE 3.8L (92-01)

GRAND PRIX 3.4L (96) 3.8L (97-01)

11 DIENTES CW

LESTER 6431, 6472



CLAVE: M64908

NUM. PARTE: 6490N

MARCHA NUEVA DELCO PG260L 12V.

BUICK RAINIER 4.2L 04-05

CHEVROLET COLORADO

GMC CANYON 2.8L, 3.5L 04-06

CHEVROLET TRAILBLAZER

GMC ENVOY 4.2L 02-05

HUMMER H3 3.5L 2006

ISUZU ASCENDER 4.2L 03-05

ISUZU I-280, I-350 2.8L, 3.5L 2006

OLDSMOBILE BRAVADA 4.2L 02-04

SAAB 9-7X 4.2L 2005

DELCO 9000875 (2-2141-DR-2)

11 DIENTES



Marchas Sistema Delco

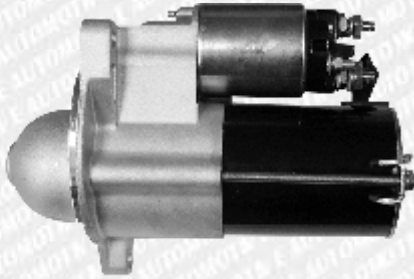

CLAVE: M67277
NUM. PARTE: 6727N
MARCHA NUEVA DELCO PG260G 12V
FORD PICK-UP 4.2L (MEXICO) 99-08
DELCO 9000869
FORD XL34-11000-AA
2-3056-DR
10 DIENTES

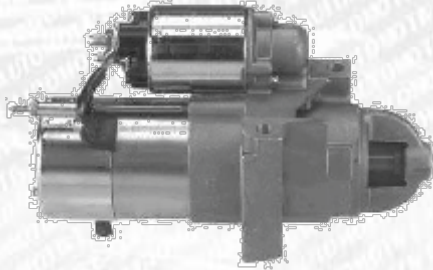

CLAVE: M16906
NUM. PARTE: 2-1690-DR
MARCHA DELCO PG-260M 1.7KW 12V ESCALADE 5.7L (99-00)
BLAZER 5.3L (96-98), 5.7L (1994); CK SERIES PICK UP/SIERRA
5L (1999), 5.7 Y 7.4 (94-00); G SERIES VAN (94-96) 7.4 Y 5.7L;
SAVANA (99-02) 5.7/7.4L (96-02) SILVERADO/SIERRA 8.1L (01-02)
6L (1999) SUBURBAN 5.7/7.4L (94-99) 8.1L (01-02)
TAHOE/YUKON 5.7L (95-00) EXPRESS G3500 5.7/8.1L (96-02)
G1500 (96-02) 5.0/5.7L
11 DIENTES CW
LESTER 6449 2-2143-DR-2

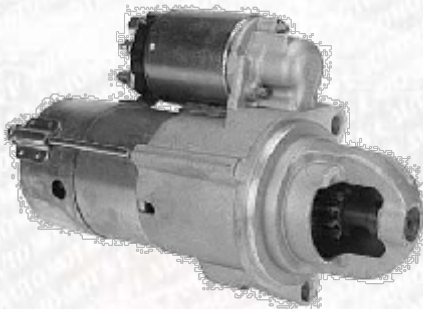

CLAVE: M16922
NUM. PARTE: 2-1692-DR2
MARCHA DELCO REMY ORIGINAL PG260M 1.7KW 12V IMANES
PERMANENTES CADILLAC 4.6L ALLANTE (1993)
DEVILLE (94-00) EL DORADO/SEVILLE (93-00);
OLDSMOBILE AURORA 4.0L (95-01)
9 DIENTES CW
LESTER 6471
DELCO 9000-805, -862



CLAVE: M64734
NUM. PARTE: 2-1790-DR
MARCHA DELCO SD205 1.6 KW 12V BUICK (1996) REGAL/MONTE
CARLO 3.1L, BERETTA/CORSICA/CENTURY 2.2L, 3.1L,
LUMINA/LUMINA MINIVAN/SILHOUETTE 3.4L; (96-98)
SKYLARK/PONTIAC GRAND AM 3.1L, SUNFIRE/CAVALIER 2.2L;
(96-97) GRAND PRIX/CUTLASS 3.1L; (97-98) S,T SERIES
PICK UP/SONOMA 2.2L
9 DIENTES CW
LESTER 6473

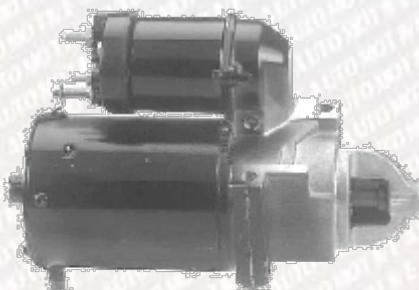

CLAVE: M17967
NUM. PARTE: 2-1796-DR
MARCHA DELCO SD255 12V (97-99) CHEVROLET CK SERIES
PICK UP/GMC SIERRA 4.3L, 5L, 5.7L, EXPRESS/SAVANA VANS
4.3L, 5L; GMC-CHEVROLET SUBURBAN 5.7L (97-98)
ESCALADE 5.7L (99-00), TAHOE/YUKON 5.7L (98-00)
9 DIENTES CW
LESTER 6483
12558851
DELCO 10455065



Marchas Sistema Delco

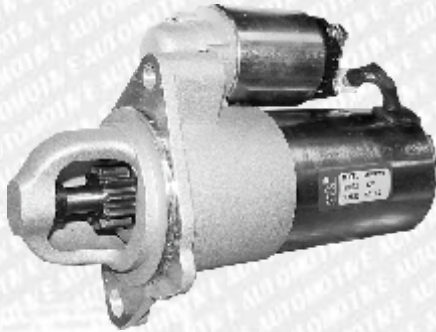

CLAVE: M18197
NUM. PARTE: 2-1819-DR
MARCHA DELCO PG260M 1.7KW 12V PMGR (99-00)
CAVALIER/ALERO/PONTIAC GRAND AM/SUNFIRE 2.4L;
MALIBU 2.4L (97-99)
11 DIENTES CW
LESTER 6480
DELCO 9000-804, -861

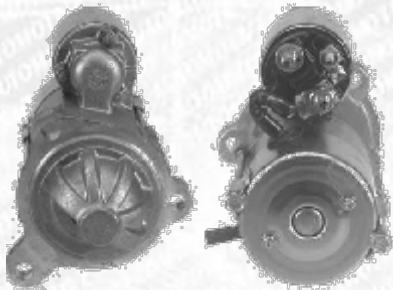

CLAVE: M19129
NUM. PARTE: 2-1912-DR
MARCHA DELCO PG260M SERIES PMGR 1.7KW 12V
CHEVROLET/GMC MEDIUM DUTY
TRUCKS 6.0L, 7.0L, 7.4L, 8.1L;
TOPKICK/KODIAK 6.0/7.0L (96-98), 7.4L (99-00),
8.1L (01-05)
9 DIENTES CW
LESTER 6452
DELCO 10465375,
90008-12, -64

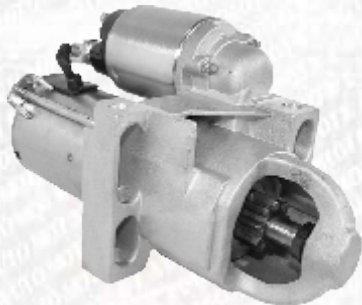

CLAVE: M19541
NUM. PARTE: 2-2112-DR-2
MARCHA DELCO PG260F2 1.5KW 12V (01-04) ASTRO/SAFARI/
BLAZER/GMC JIMMY/EXPRESS/SAVANA/ST SERIES
PICK UP/SONOMA/SILVERADO/SIERRA 4.3L (2001)
TRAILBLAZER/ENVOY/BRAVADA 4.3L
11 DIENTES CW
LESTER 6485
DELCO 9000-841, -858, -871, -910, -964, -973

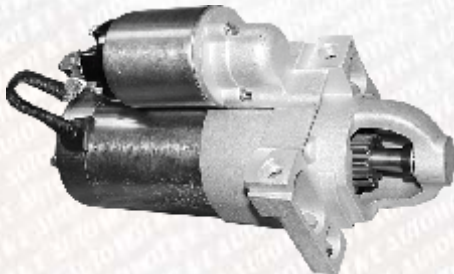

CLAVE: M22542
NUM. PARTE: 2-2054-DR-2
MARCHA DELCO PG260F2 1.5KW 12V (99-02) SILVERADO/
SIERRA 4.8L, 5.3L; (00-02) SUBURBAN/YUKON XL 5.3L,
TAHOE/YUKON 4.8L, 5.3L; (2002) AVALANCHE/ESCALADE 5.3L;
(2003) EXPRESS G1500-G2500/TRAILBLAZER 5.3L
11 DIENTES CW
LESTER 6488, 6489
DELCO 9000-842, -854, -873, -925

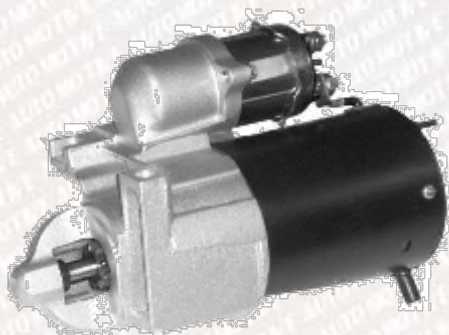

CLAVE: M15641
NUM. PARTE: 2-1412-DR
MARCHA DELCO 5MT SERIE SD-210 1.3KW 12V 90-95)
BERETTA/CAVALIER 2.2L, 3.1L; (91-92) ISUZU RODEO 3.1L;
(91-95) ISUZU PICK UP/BUICK REGAL/CUTTLASS/SILHOUETTE/
GRAND PRIX/TRANS SPORT/LUMINA 3.1L; (94-96)
SONOMA 2.2L; (1995) CENTURY 2.2/3.1L,
MONTE CARLO/GRAND AM 3.1L, SUNFIRE 2.2L
9 DIENTES CW
LESTER 6415
DELCO 10455-10, -25, -48, -53, -60



Marchas Sistema Delco

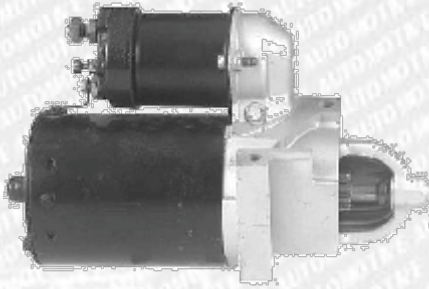

CLAVE: M14137

NUM. PARTE: 2-1413-DR

MARCHA DELCO 5MT SD200 12V (81-89) BLAZER/GMC JIMMY 2.8L, 5L; (81-85) GMC-CHEVROLET SUBURBAN 5L; (82-90) CAMARO 2.8L, 3.1L, 5L, FIREBIRD 2.8L, 3.1L; (1988) CAVALIER/CELEBRITY 2.8L; (90-93) SONOMA 2.8L; (84-86) JEEP CHEROKEE/WAGONEER 2.8L, (1986) JEEP COMANCHE 2.8L, (91-92) ISUZU RODEO 3.1L LESTER 6313 3562, 3569 DELCO 10455016, 11095-28, -35; 1998-427, -524
9 DIENTES CW



CLAVE: M30589

NUM. PARTE: 2-3058-DR

MARCHA DELCO PG260D 12V CHEVROLET UPLANDER 2006-2008 V6 3.9L PONTIAC MONTANA 06-07 V6 3.9L; BUICK (06-07), CHEVROLET (06-08), PONTIAC (06-08) 8000063 LESTER 6784
9 DIENTES

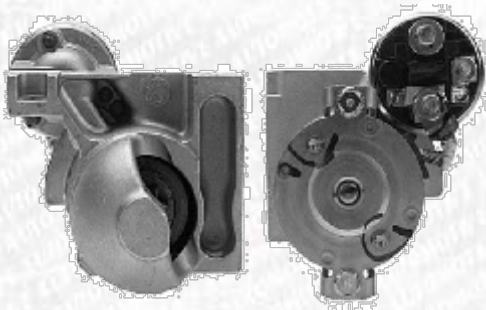

CLAVE: M12566

NUM. PARTE: 2-2110-DR

MARCHA DELCO PG260D 12V (01-05) BUICK CENTURY 3.1L, IMPALA/MONTE CARLO/VENTURE/GRAND AM/MONTANA/AZTEK 3.4L, MALIBU 3.1/3.5L; (2005) EQUINOX 3.4L, MONTANA/UPLANDER/PONTIAC G6 3.5L; (2001) LUMINA 3.1L; (2002) CAVALIER/SUNFIRE 2.2L,
9 DIENTES CW
LESTER 6491
DELCO 8000058, 9000-868, -901, -951, 125-63764, -70255, -79131, -93764

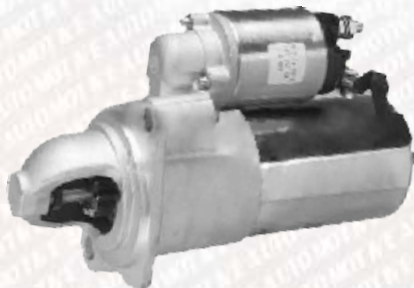

CLAVE: M21143

NUM. PARTE: 2-1819-DR-2

MARCHA DELCO PG260M 1.6KW 12V (99-02) CAVALIER/GRAND AM/SUNFIRE/ALERO 2.4L; (97-99) MALIBU 2.4L
11 DIENTES CW
LESTER 6480
DELCO 9000804, -861

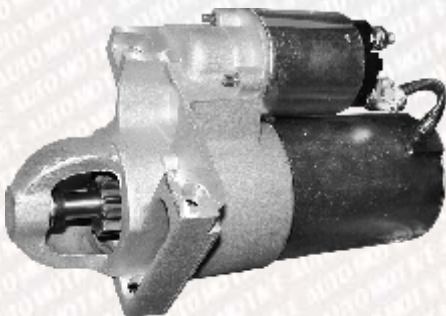

CLAVE: M21405

NUM. PARTE: 2-1688-DR-2

MARCHA DELCO PG260L 12V (1994) BUICK REGAL 3.8L, (1996) CUTLASS/GRAND PRIX 3.4L, (95-97) CAMARO/FIREBIRD 3.8L, (96-97) LUMINA/MONTE CARLO 3.4L; SUPERCARGADO 3.8L: (91-03) BUICK PARK AVENUE, (97-03) BUICK REGAL/PONTIAC GRAND PRIX, (92-95) OLDSMOBILE 98, (95-98) OLDSMOBILE 88 (92-03) BONNEVILLE
11 DIENTES CW
LESTER 6431, 6472
DELCO 9000-776, -797, -806, -863, -882



Marchas Sistema Delco

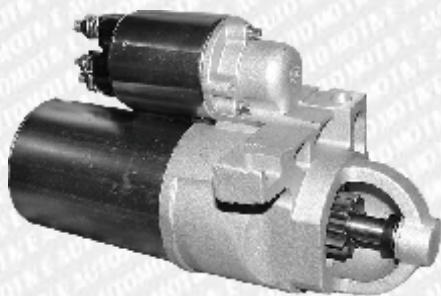

CLAVE: M21421
NUM. PARTE: 2-2142-DR
MARCHA DELCO PG260M 12V (97-01) CORVETTE 5.7L, (98-01) CAMARO 5.7L, (98-01) FIREBIRD 5.7L, (00-01) SILVERADO/SUBURBAN/GMC SIERRA/ YUKON 6L
11 DIENTES CW
LESTER 6482
DELCO 9000834, 866



CLAVE: M21447
NUM. PARTE: 2-2144-DR-2
MARCHA DELCO PG260D 12V (02-04) ALERO 2.2L, (02-05) GRAND AM/SUNFIRE 2.2L, (04-05) CAVALIER 2.2L, (06-07) PONTIAC G6/SOLSTICE 2.4L, CHEVROLET HHR 2.2/2.4L, (2007) PONTIAC G5 2.2/2.4L, SOLSTICE 2.0L
9 DIENTES CW
LESTER 6493
DELCO 8000079; 9000-856, -933, -959, -976, -977



CLAVE: M09318
NUM. PARTE: 12609317
MARCHA NUEVA DELCO GM HHR 2.0, 2.2 Y 2.4L 08-09; MALIBU 2.2, 2.4L 08-09; PONTIAC G4 2.0, 2.2 Y 2.4L 08-09; G5 2.2L 08-09; SOLSTICE 2.0 Y 2.4L 08-09; CAVALIER 2000=>; HUMMER H3, SENTRA 2003; LESTER 6947 8000213 140-6039F

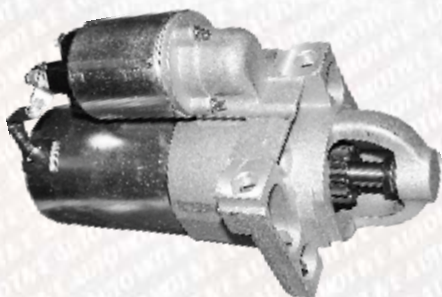

CLAVE: M22002
NUM. PARTE: 2-2200-DR
MARCHA DELCO PG260L 12V (98-02) CAMARO/FIREBIRD 5.7L, (97-04) CORVETTE 5.7L, (00-05) SILVERADO/SIERRA/SUBURBAN 6.0L, (01-05) YUKON/ XL 6.0L (03-05) AM GENERAL HUMMER/EXPRESS/SAVANA 6.0L, (02-05) ESCALADE 6.0L
11 DIENTES CW
LESTER 6482, 6492
DELCO 8000052; 9000-834, -853, -866, -878, -880, -927, -931, -962



CLAVE: M22117
NUM. PARTE: 2-2211-DR-2
MARCHA DELCO PG260F2 1.5KW 12V (99-02) SILVERADO/SIERRA 4.8L, 5.3L; (00-02) SUBURBAN/YUKON XL 5.3L, TAHOE/YUKON 4.8L, 5.3L; (2002) AVALANCHE/ESCALADE 5.3L; (2003) EXPRESS G1500-G2500/TRAILBLAZER 5.3L
11 DIENTES CW
LESTER 6488, 6489
DELCO 9000-842, -854, -873, -925



Marchas Sistema Delco



CLAVE: M01254

NUM. PARTE: 2-1593-DR

MARCHA GM DELCO 10MT BUICK 78-79 V8;
CHEVROLET BEL AIR 73-75 V8 5.7, 7.4, 6.6L;
CHEV BLAZER 75-83; C,K, SERIES PICK UP 73-83;
CAMARO 73-81; CAPRICE 73-79; CORVETTE 73-81;
G SERIES VAN 75-83; MALIBU 73-79; MONTE CARLO 73-77;
NOVA 73-79; P SERIES STEP VAN 73-81; SUBURBAN 73-83;
JIMMY 73-83 (V8 5.7L, 6.6L Y 7.4L) 1206 2-1593-DR



CLAVE: M64940

NUM. PARTE: 2-2336-DR

MARCHA DELCO PG260D 12V (03-05) ESCALADE 5.3L, (03-08)
SILVERADO/SIERRA/TAHOE/YUKON 4.8 Y 5.3L,
SUBURBAN/AVALANCHE 5.3L, (04-07)
EXPRESS/SAVANA 4.8 Y 5.3L, (04-09)
TRAILBLAZER/ENVOY 5.3L

9 DIENTES CW

LESTER 6494

DELCO 8000045, 9000939,
12578050, 12592294

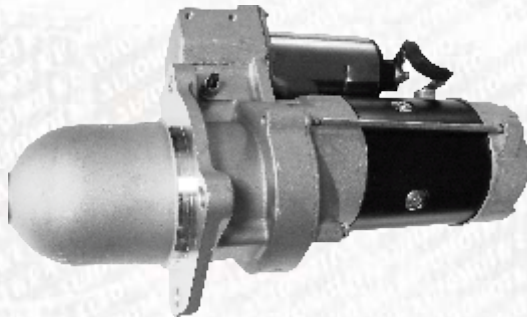

CLAVE: M34493

NUM. PARTE: 10479637

MARCHA DELCO 28MT 3KW 12V MERCEDES BENZ
ECOPOWER, FREIGHTLINER, CAMIONES STERLING
MEDIUM Y HEAVY DUTY

9 DIENTES CW

LESTER 6604, 6610

DELCO 104614-54, -76; 104796-45, -48

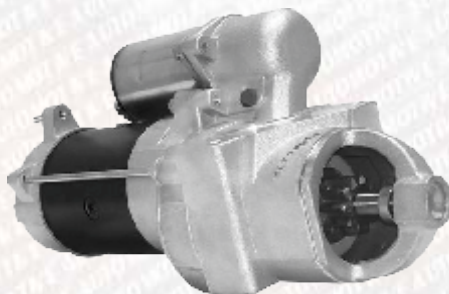

CLAVE: M15802

NUM. PARTE: 50-8402-2

MARCHA DELCO 28MT 12V OSGR 2.5KW (1994) BLAZER 6.5L,
(82-91) BLAZER/GMC JIMMY 6.2L, (82-00) GMC CK SERIES
PICK UP, 6.2 Y 6.5L, (82-99) GMC SUBURBAN 6.2 Y 6.5L,
(94-99) TAHOE/YUKON 6.5L

10 DIENTES CW

LESTER 3764, 6469

DELCO 1109-219, -563; 1113-267,
-270, -296, -589; 1998442

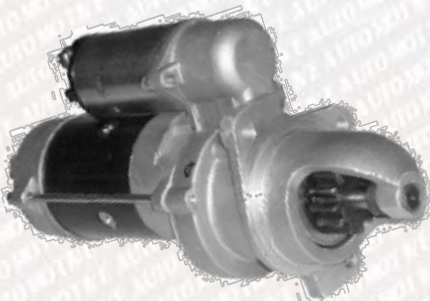

CLAVE: M84036

NUM. PARTE: 50-8403

MARCHA DELCO 28 MT 12V BOBCAT, CLARK, FORD NEW
HOLLAND, HYSTER, PERKINS, LISTER PETER

12 DIENTES CW

LESTER 6571

DELCO 1113273



Marchas Sistema Delco



CLAVE: M84049
NUM. PARTE: 50-8404
MARCHA DELCO 28 MT 12V BOBCAT, CLARK, FORD NEW HOLLAND, MASSEY FERGUSON, PERKINS, PERKINS MARINO
10 DIENTES CW
LESTER 6576
DELCO 1113-281, -282



CLAVE: M84170
NUM. PARTE: 50-8417
MARCHA DELCO 28MT 12V 10 DIENTES MONTACARGAS HYSTER CON MOTOR PERKINS 6-354
10 DIENTES CW
LESTER 4392
DELCO 1113290



CLAVE: M64223
NUM. PARTE: 50-8420
MARCHA NUEVA DELCO 28 MT 12V 2.9 KW CUMMINS, WHITE, FREIGHTLINER, BOBCAT CON CAMPANA
51-8404 6422-SDX
LESTER 6573N 6583N
2-1749-DR 50-8437
10 DIENTES

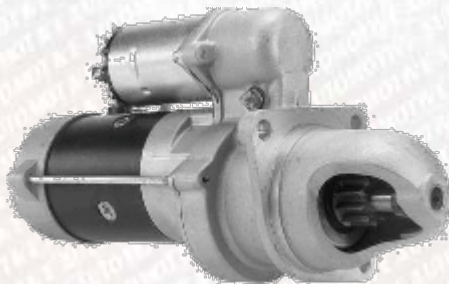

CLAVE: M84226
NUM. PARTE: 50-8422
MARCHA DELCO 28MT 12V BOBCAT, CLARK, JOHN DEERE MARINO/INDUSTRIAL/AGRICOLA,
10 DIENTES CW
LESTER 6570

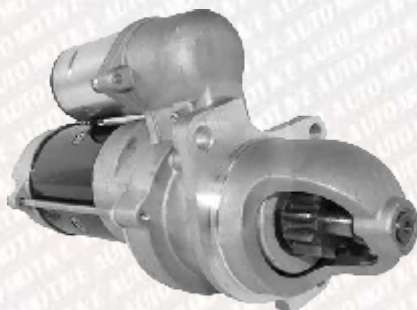

CLAVE: M84315
NUM. PARTE: 50-8431
MARCHA DELCO 28MT 2.9KW 12V LISTER-PETTERS AGRICOLA/INDUSTRIAL
10 DIENTES CW
LESTER 6587
DELCO 10461463, 10479607



Marchas Sistema Delco



CLAVE: M84255
NUM. PARTE: 50-8425
MARCHA NUEVA DELCO 28 MT 12V
CUMMINS,
10479615, 10479618
LESTER 6585N
10 DIENTES



CLAVE: M84213
NUM. PARTE: 50-8421
MARCHA NUEVA DELCO 28 MT 24V
CONSOLIDATED DIESEL,
CUMMINS 1113277, 1113291 6574, 6582N
10 DIENTES



CLAVE: M23894
NUM. PARTE: 2-2389-DR
MARCHA DELCO 29MT 3.3KW 12V PLGR MERCEDES BENZ
ECOPOWER, FREIGHTLINER CON MOTOR MERCEDES
9 DIENTES CW
LESTER 6842
DELCO 8200-011, -103; 10461772, 19011403

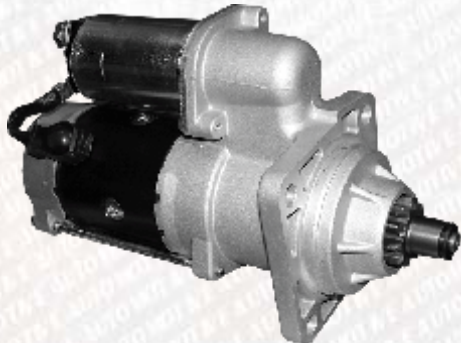

CLAVE: M23909
NUM. PARTE: 2-2390-DR
MARCHA DELCO 29MT 3.3KW 12V AUTOBUSES INTERNATIONAL;
CAMIONES CON MOTOR DIESEL IHC VT-365 6L
10 DIENTES CW
LESTER 6843
DELCO 10461764; 19011-404, -407

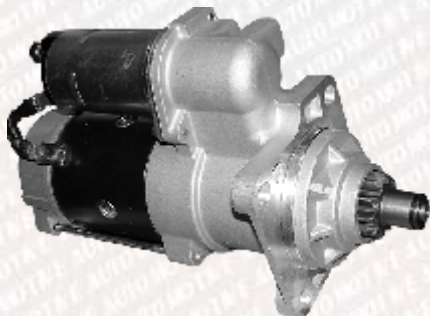

CLAVE: M68415
NUM. PARTE: 2-2704-DR-2
MARCHA DELCO 29MT 3.3KW 12V PLGR FREIGHTLINER,
CAMIONES STERLING, FORD F600 / F700 / F800 / F900/L6000 /
L7000 / L8000 / L9000 CUMMINS 5.9L 359 FD1060 (92-99)
10 DIENTES CW
LESTER 6841
DELCO 8200067, 10461771, 19011402



Marchas Sistema Delco



CLAVE: M22352
NUM. PARTE: 2-2357-DR-1
MARCHA DELCO 29MT 12V PLGR
FREIGHTLINER/FORD/STERLING/KENWORTH
CON MOTOR CUMMINS ISB
10 DIENTES CW
LESTER 6840
DELCO 8200010, 10461770, 19011400



CLAVE: M68457
NUM. PARTE: 10479646
MARCHA DELCO 29MT 12V 3.3KW OM904, 4.3L
MERCEDES DSL 02-06, OM924LA, 4.8L 05-07, FL 50
MBE900 00-04, FL60 L6 6.4L 388 CID 00-03, FL70 L6 6.4L 00-03,
FL80 MBE900 00-04, ACTERRA M5500/6500/7500/8500
MERCEDES MBE 900 01-07, L-LINE 7500/8000/8500/9500
MERCEDES MBE900 06-07
9 DIENTES
LESTER 6845,6842
DELCO 8200003,

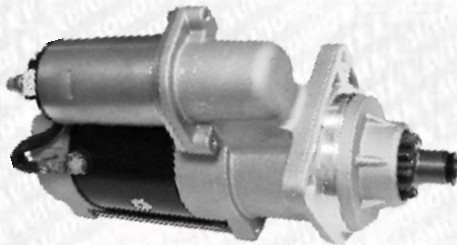

CLAVE: M29602
NUM. PARTE: 8200296
MARCHA DELCO 29MT 24V MB ALLEGRO
11 DIENTES CW



CLAVE: M22977
NUM. PARTE: 8200297
MARCHA DELCO 29MT 24V IRIZAR
11 DIENTES CW



CLAVE: M37653
NUM. PARTE: 141-349
MARCHA DELCO 37MT 12V JOHN DEERE MOTORES
6068, 6076, 6059, 6081 NEW HOLLAND TX66/FORD 6-456 (94-97)
TX68/FORD 6-576 (95-97)
10 DIENTES CW
LESTER 6465
DELCO 10461416, 1047895



Marchas Sistema Delco



CLAVE: M22073
NUM. PARTE: 2-2207-DR-1
MARCHA DELCO 4.5KW 37MT 24V EXCAVADORA
SAMSUNG SE170/SE210 CUMMINS 5.9 (92-98)
10 DIENTES CW
LESTER 6269 3908594
DELCO 1993903

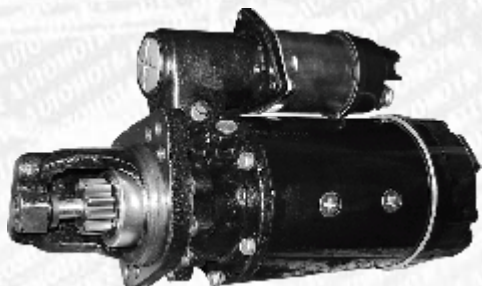

CLAVE: M01591
NUM. PARTE: 50-159-1
MARCHA DELCO SERIES DD 37MT 12V JOHN DEERE,
PERKINS MARINO
10 DIENTES CW
LESTER 6387, 6410
DELCO 11136-40, -41, -44, -50, -51, -53, -56, -72, -76, -90;
19903-15, -18, -26; 1993-754, -762, -799, -881



CLAVE: M16058
NUM. PARTE: 50-160
MARCHA DELCO SERIES DD 37MT 6.9KW 24V CLARK,
CUMMINS 8.3L, DETROIT/LISTER DIESEL 3-53,
MOTORES WAUKESHA
12 DIENTES CW
LESTER 6292, 6293, 6358, 6359
DELCO 19903-30, -32; 19937-07, -29, -32;
19939-01, -02, -09, -10; 10479175



CLAVE: M01618
NUM. PARTE: 50-161
MARCHA DELCO SERIES DD 37MT 12V CLARK CON MOTOR
DIESEL PERKINS 4-248/6-354, FORD 6.6L/7.8L DIESEL,
TRACTORES INTERNATIONAL D-246 DIESEL
10 DIENTES CW
LESTER 6382
DELCO 199-0309, -3769, -3886; 10461003, 6-354

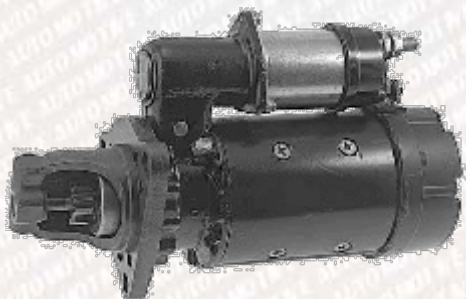

CLAVE: M37009
NUM. PARTE: 50-162-1
MARCHA DELCO 37MT 12V SERIES DD MOTORES CUMMINS,
INTERNATIONAL NAVISTAR, WAUKESHA
12 DIENTES CW
LESTER 6380 3910643;
DELCO 19903-16, -17, -19; 1993-713, -763,
-778, -794, -871, -874, -931; 10461008



Marchas Sistema Delco



CLAVE: M15828
NUM. PARTE: 2-1582-DR-1
MARCHA DELCO 37MT SERIES DD MEDIUM HEAVY DUTY TRUCKS (90-02) CHEVROLET/GMC MOTOR DIESEL CATERPILLAR 3116, (95-97) FORD L6000 /7000/8000/9000 CATERPILLAR 3126. KODIAK, TOPKICK 6.6L/7.2L
10 DIENTES CW
LESTER 6504

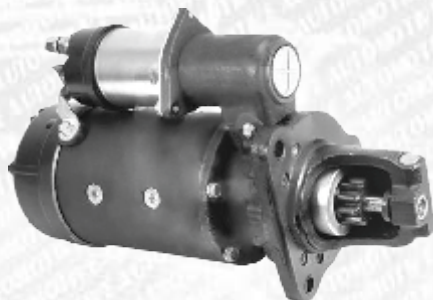

CLAVE: M22060
NUM. PARTE: 2-2206-DR
MARCHA DELCO 37MT SERIES DD 12V INTERNATIONAL IHC NAVISTAR T444-E 1652/1654 7.3L (93-03), FORD F650/F750 7.3L (99-01) DIESEL
10 DIENTES CW
LESTER 6297
DELCO 10478890



CLAVE: M23719
NUM. PARTE: 2-2371-DR
MARCHA SISTEMA DELCO 38MT PLGR 12V BLUEBIRD 04-08; FREIGHTLINER 00-07; STERLING 01-08.
LESTER 6831N 19026035 8200075
11 DIENTES

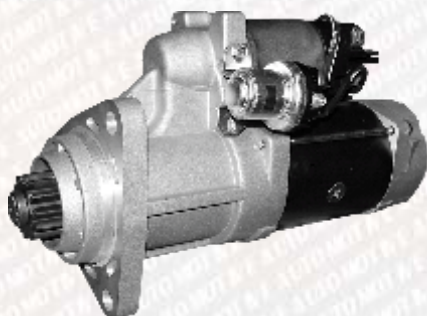

CLAVE: M23722
NUM. PARTE: 2-2372-DR
MARCHA DELCO 38MT 4.6KW 12V PLGR FREIGHTLINER/ PETERBILT CON MOTOR CUMMINS ISC 8.3L, STERLING CON CATERPILLAR C-7, INTERNATIONAL DT466 7.6L
12 DIENTES CW
LESTER 6808
DELCO 820000-5, -25, 8300005, 10461769, 190260-28, -29

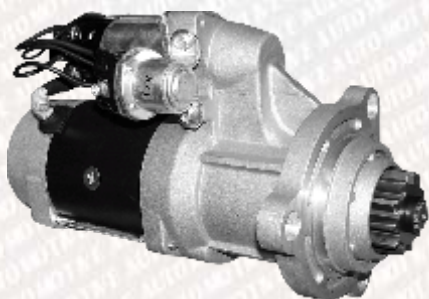

CLAVE: M23472
NUM. PARTE: 2-2347-DR1
MARCHA DELCO 39MT 12V FREIGHTLINER, INTERNATIONAL, CAMIONES VOLVO CON CATERPILLAR C10, C11, C12, C13, C15; MOTORES CUMMINS ISX
11 DIENTES CW
LESTER 6804, 6806
DELCO 82000-33, -40; 104617-53, -77; 190115-06, -16, -18



Marchas Sistema Delco



CLAVE: M28042
NUM. PARTE: 2-2804-DR
MARCHA NUEVA DELCO 39MT 12V
FREIGHTLINER,
INTERNATIONAL,
VOLVO TRUCK W/
CATERPILLAR C10, C1, C12, C13, C15;
10461753 LESTER 6822, 6824, 6825, 6911N
POSICION DEL SOLENOIDE 82°.
11 DIENTES 2-2366-DR 8200289



CLAVE: M22859
NUM. PARTE: 2-2805-DR
MARCHA DELCO 39MT CON TERMOSTATO OCP 12V
KENWORTH PETERBIT CON CATERPILLAR C9, C10,
C11, C12, C15; CUMMINS ISM, ISX MOTOR DIESEL
11 DIENTES
8200050 8200090 LESTER 691 6856 .
POSICION DEL SOLENOIDE 88°.



CLAVE: M69244
NUM. PARTE: 6924N
MARCHA NUEVA DELCO 39MT 12V
MOTORES NAVISTAR, CUMMINS
DELCO 8200308
11 DIENTES



CLAVE: M68372
NUM. PARTE: 6837N
MARCHA NUEVA DELCO 39MT 24 VOLT,
DELCO 8200330
11 DIENTES CW

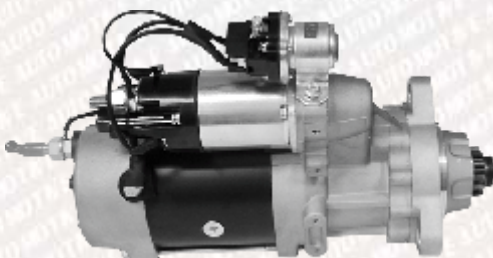

CLAVE: M69070
NUM. PARTE: 6907N
MARCHA NUEVA DELCO 39MT 12 VOLT, 7.3KW/
DELCO 8200433
12 DIENTES CW,



Marchas Sistema Delco

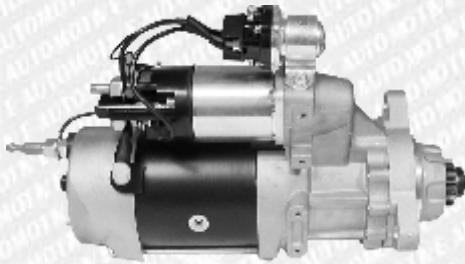

CLAVE: M68238
NUM. PARTE: 6823N
MARCHA NUEVA DELCO 39MT 24 VOLT,
DELCO 8200435
12 DIENTES CW

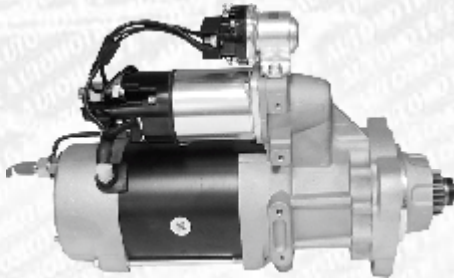

CLAVE: M69198
NUM. PARTE: 6919N
MARCHA NUEVA DELCO 39MT 12 VOLT,7.3KW/
DELCO 8200434
12 DIENTES CW

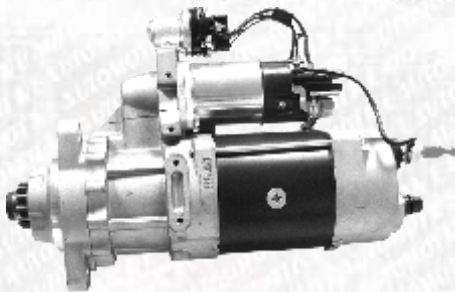

CLAVE: M68575
NUM. PARTE: 6857N
MARCHA NUEVA DELCO 39MT 24 VOLT,
MERCEDES 4000 DETROIT DD13, 15
DELCO 8200436
12 DIENTES CW



CLAVE: M29311
NUM. PARTE: 2-2931-DR
MARCHA DELCO 41MT 12V BENDIX
KENWORTH, STERLING CON
CUMMINS 8.9L ISC, POSICION DEL SOLENOIDE 82°
10478999
12 DIENTES
LESTER 6400 6613 10461169



CLAVE: M66347
NUM. PARTE: 6634
MARCHA DELCO 41MT 24V
ATLAS COPCO AGRICOLA E INDUSTRIAL
CUMMINS C8.3 1997; CATERPILLAR 94-97,
CAT 3116 91-96. 3E2298, 8C4773, 10461239,
10478817 141-377
12 DIENTES



Marchas Sistema Delco



CLAVE: M01520
NUM. PARTE: 50-152
MARCHA 42MT 24V DELCO SERIES DD 7.6KW
12 DIENTES
23381A LESTER 6360
SMR-4406 M44069



CLAVE: M50157
NUM. PARTE: 50-150
MARCHA 42MT DELCO SERIES
DD 7.6KW 12V .
12 DIENTES
SMR-4201 M42018



CLAVE: M30125
NUM. PARTE: 50-153-1
MARCHA UNIPOINT DELCO 42 MT 12V
CATERPILLAR, CUMMINS, DELCO
CHEVROLET GMC SMR-4211
LESTER 6351, 6352, 6356
1990483 23373A 1990358 1990391
POSICION DEL SOLENOIDE A 82 GRADOS IZQUIERDA
11 DIENTES



CLAVE: M27036
NUM. PARTE: 2-2703-DR
MARCHA UNIPOINT DELCO 42MT 12V
FREIGHTLINER, KENWORTH, STERLING, VOLVO TRUCK,
MOTOR CATERPILLAR O CUMMINS 1990490 10461042
10461053 6511N 1990489, 10461062, 10461075, 10479080,
10479105
11 DIENTES
LESTER 6554, 6511 POSICION DEL
SOLENOIDE A 88 GRADOS DERECHA 2-2995-DR

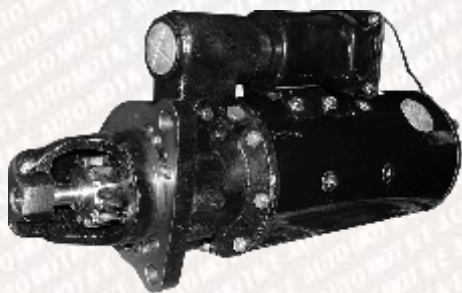

CLAVE: M51118
NUM. PARTE: 50-111
MARCHA DELCO 50MT 24V
LESTER 4930 POSICION DEL SOLENOIDE A 38 GRADOS
CAMPANA 51-167 323-761 323-768
739911C9
11 DIENTES



Marchas Sistema Delco



CLAVE: M24738
NUM. PARTE: 3905N
MARCHA NUEVA DELCO 50MT 12V
LESTER 3905 1109295,1109545,1109554
11 DIENTES

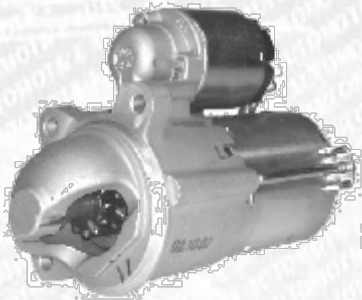

CLAVE: M10005
NUM. PARTE: 2-3057-DR
MARCHA NUEVA DELCO 12V
FORD F-350 PICK UP HEAVY DUTY F-150 F-250 F-450
TRITON 99=> 3 OREJAS XC35-11000-AB 90002
LESTER 6797 9000870
12 DIENTES



CLAVE: M93178
NUM. PARTE: 12609317
MARCHA DELCO ORIGINAL GM PMGR 2.0 Y 2.2L;
CAVALIER 2000=>; HUMMER H3, SENTRA 2003
9 DIENTES CW
LESTER 6947
DELCO 323-1657
8000213 140-6039F

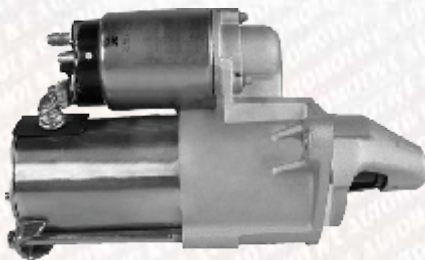

CLAVE: M67264
NUM. PARTE: 6726N
MARCHA DELCO KOREA PMGR 12V.
CHEVROLET 04-08, DAEWOO 99-02 ,
PONTIAC 05-08, SUZUKI 04-08,
CHEVROLET AVEO 07-08, ZUZUKI SWIFT 07-08,
LESTER 30716, 6723
DELCO 10455506, 19134005, 9000700
9 DIENTES

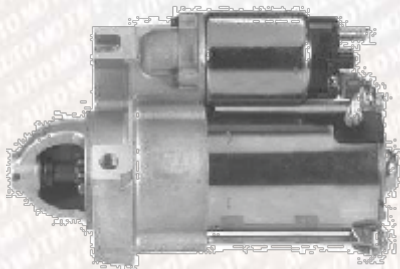

CLAVE: M18142
NUM. PARTE: 2-1814-DR
MARCHA PG260F1 1.4KW 12V (97-00) CENTURY//MALIBU/
MONTE CARLO/LUMINA 3.1L, PONTIAC GRAND AM/TRANS
SPORT/IMPALA/VENTURE/MONTE CARLO/ALERO/SILHOUTTE
3.4L; (98-01) CAVALIER 2.2L/ST SERIES PICK UP/
SONOMA 2.2L; CUTLASS 3.1L (97-99), PONTIAC GRAND
PRIX 3.1L (98-99), SUNFIRE 2.2L (98-00)
9 DIENTES CW
LESTER 6481
DELCO 90008-33, -47, -59



Marchas Sistema Delco

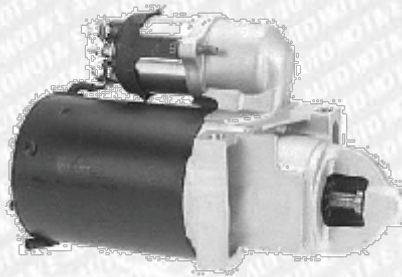

CLAVE: M64164

NUM. PARTE: 2-1470-DR

MARCHA 5MT 12V SERIE SD-260 (90-95) SONOMA 4.3L,
(90-96) CHEVROLET CK SERIES PICK UP/SIERRA 4.3, 5.0L,
(91-96) ASTRO/BLAZER/GMC JIMMY/SAFARI 4.3L,
CHEVROLET-GMC G SERIES VAN 4.3, 5.0L

9 DIENTES CW

LESTER 6416

DELCO 104550-13, -42, -50, -70



CLAVE: M35394

NUM. PARTE: 23539-A

MARCHA DELCO 4.5KW 37MT 24V EXCAVADORA
SAMSUNG SE170/SE210 CUMMINS 5.9 (92-98)

10 DIENTES CW

LESTER 6269 3908594

DELCO 1993904



CLAVE: M35906

NUM. PARTE: 23359-A

MARCHA 40 MT 24V DINA RCP
POSICION DEL SOLENOIDE 38°
50-104-1

11 DIENTES

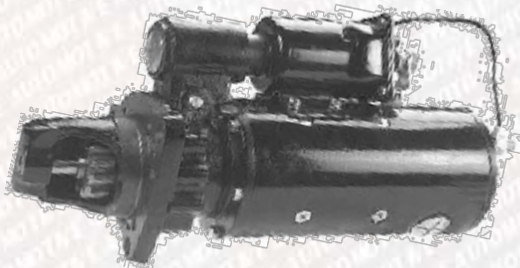

CLAVE: M01080

NUM. PARTE: 50-108-1

MARCHA 40 MT 12V DINA
23350-A POSICION DEL SOLENOIDE 52°

11 DIENTES



CLAVE: M51017

NUM. PARTE: 50-100-1

MARCHA 40 MT 12V DINA
POSICION DEL SOLENOIDE 82°
LESTER 3339, 3374

12 DIENTES



Marchas Sistema Delco

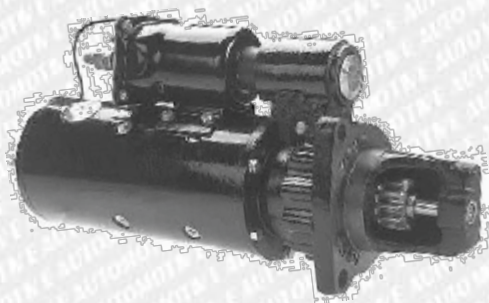

CLAVE: M01035
NUM. PARTE: 50-103
MARCHA 40 MT 24V DINA
23353-A POSICION DEL SOLENOIDE 278°
12 DIENTES



CLAVE: M01048
NUM. PARTE: 50-104-1
MARCHA 40 MT 24V DINA
11 DIENTES
LESTER 3745, 3785, 3979,6260 23359A
POSICION DEL SOLENOIDE 38°



CLAVE: M00412
NUM. PARTE: 2-2472-DR
MARCHA COMPLETA 41MT 12V BENDIX 12D
10478818 LESTER 6630 23533-A



CLAVE: M35061
NUM. PARTE: 233506-A
MARCHA 41 MT 12V RCP 10479165
LESTER 6665

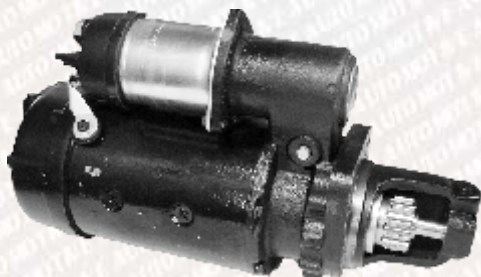

CLAVE: M23590
NUM. PARTE: 23597-A
MARCHA 41 MT 24V
12 DIENTES
RCP CANADA



Marchas Sistema Delco



CLAVE: M23371
NUM. PARTE: 23373-A
MARCHA 42 MT 12v. RCP CANADA
11 DIENTES



CLAVE: M01517
NUM. PARTE: 50-151-3
MARCHA 42 MT 24V
11 DIENTES
10478998 LESTER 6370 6378 3745 23374A



CLAVE: M33749
NUM. PARTE: 23374-A
MARCHA 42 MT 24v. RCP
11 DIENTES

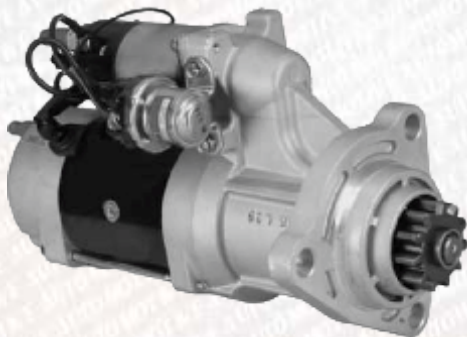

CLAVE: M23675
NUM. PARTE: 2-2367-DR
MARCHA NUEVA DELCO 39MT 6.4KW 12V PLGR
CATERPILLAR C15,
CUMMINS 15X 15.0L;
DETROIT DIESEL S60;
FREIGHTLINER POSICION DEL SOLENOIDE 82°
19011521
LESTER 6822
11 DIENTES



CLAVE: M89980
NUM. PARTE: 10478998P
MARCHA DELCO REMY 42MT 24V
11 DIENTES CW
LESTER 6370
DELCO 19904-56, -85



MARCHAS SISTEMA
FORD



Marchas Sistema Ford

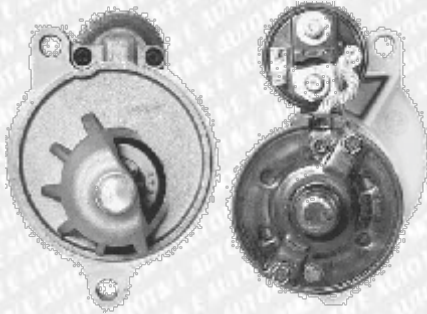

CLAVE: M32249

NUM. PARTE: 2-1164-FD

MARCHA FORD PMGR 1.4 KW, 12 V

AEROSTAR V6 4 L 90-96, EXPLORER V6 4 L 91-96,

RANGER V6 4 L 90-96, RANGER V6 2.9 L 92,

MAZDA PICK UP V6 4 L 94-97.

LESTER 3224 3239 2-1885-FD

10 DIENTES

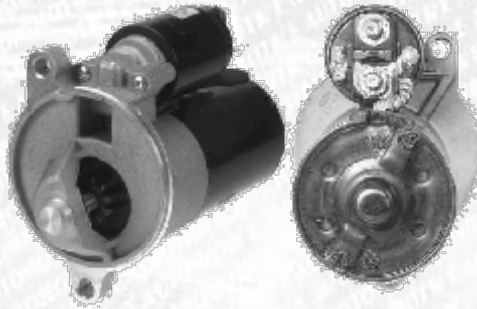

CLAVE: M21169

NUM. PARTE: 2-1165-FD

MARCHA FORD PMGR EXPLORER 91-97 V6 4L,

RANGER V6 4L 90-97, MAZDA PICK UP 94-97 V6 4L

12V 2 OREJAS

10 DIENTES

LESTER 3232 50-220

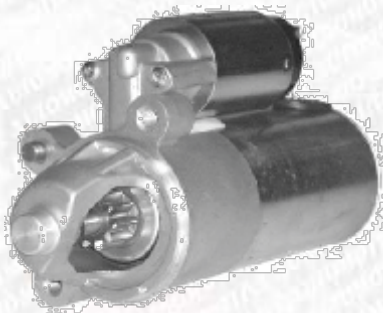

CLAVE: M21700

NUM. PARTE: 2-1557-FD

MARCHA FORD PMGR TAURUS 90-97 V6 3L 3.8L,

TOPAZ 92-94, WINDSTAR 95 V6 3L 3.8L,

LINCOLN CONTINENTAL 89-94,

MERCURY SABLE 90-97

10 DIENTES

LESTER 3204 50-217 M02172

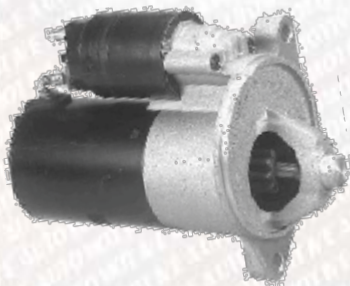

CLAVE: M15667

NUM. PARTE: 2-1566-FD

MARCHA FORD PMGR BRONCO 92-96 V8 5 Y 5.8L,

SERIES F PICK UP L6 4.9L Y SERIES F V8 5L Y 5.8L 92-97 12V

SUSTITUYE A LA MARCHA 9000043029 DE FORD BOSCH

CAMIONES STANDARD 79-86; FAIRMONT 74-84;

MUSTANG STD 74-84; COUGAR Y THUNDERBIRD STD 85-86.

10 DIENTES 2 OREJAS

LESTER 3223 3241N 2-1881-FD

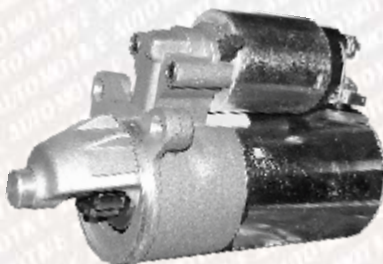

CLAVE: M15670

NUM. PARTE: 2-1567-FD

MARCHA FORD PMGR 1.4KW 12V

CROWN VICTORIA 92-95 V8 4.6L,

F SERIES PICK UP 97 V8 4.6L, MUSTANG 96 V8 4.6L,

THUNDERBIRD 94-96 V8 4.6L, LINCOLN

TOWN CAR 92-95 V8 4.6L, MERCURY

COUGAR 94-96 V8 4.6L, GRAND MARQUIS 92-95 V8 4.6L

12 DIENTES 3 OREJAS

LESTER 3221



Marchas Sistema Ford

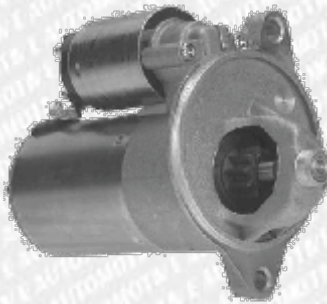

CLAVE: M15683
NUM. PARTE: 2-1953-FD-1
MARCHA FORD PMGR FORD TRUCK 93-96 12V
LESTER 3235 2-1568-FD
2 OREJAS 10 DIENTES



CLAVE: M15696
NUM. PARTE: 2-1569-FD
MARCHA FORD PMGR SERIES E VAN 92-96 V8 7.5L,
SERIES F PICK UP 92-97 V8 7.5L 12V
10 DIENTES 2 OREJAS
LESTER 3226 2-1883-FD

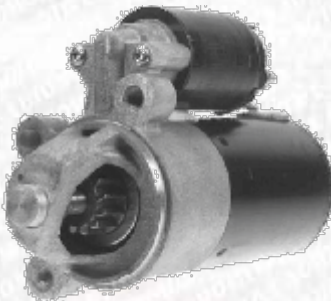

CLAVE: M15700
NUM. PARTE: 2-1570-FD
MARCHA FORD PMGR TAURUS 93-95
V6 3 Y 3.2L 12V
LESTER 3230 2-1898-FD
12 DIENTES 3 OREJAS



CLAVE: M52182
NUM. PARTE: 2-1558-FD
MARCHA FORD PMGR AEROSTAR 92-97
RANGER 91-97, TAURUS 91, TOPAZ 91-94,
PICK-UP MAZDA 94-96
LESTER 3213 50-218
AUTOMOTIVE M50217
10 DIENTES

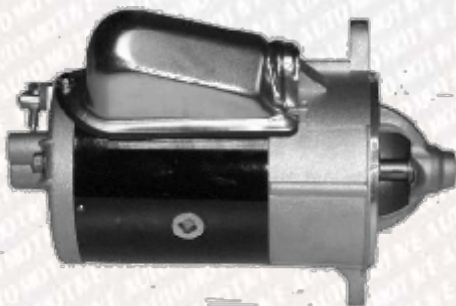

CLAVE: M16425
NUM. PARTE: 2-1642-FD
MARCHA FORD PLATINO 4" MOD II 12V
FORD BRONCO 86-91 V8 5.0LT Y 5.8LT, L6 4.9L,
FORD E SERIES VAN 83-89 V8 5.0LT Y 5.8LT, L6 4.9LT,
FORD F SERIES PICK UP 83-91 V8 5.0 LT Y 5.8LT L6 4.9L 50-205
9 DIENTES
LESTER 3185



Marchas Sistema Ford

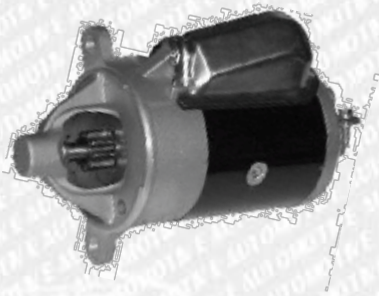

CLAVE: M02070
NUM. PARTE: 2-1649-FD
MARCHA FORD PLATINO 4" MOD II
RANGER V6 2.8L Y 2.9L 83-91
BRONCO V6 2.8 Y 2.9L 84-90
AEROSTAR V6 2.8L 86
50-207 3188 LESTER



CLAVE: M31917
NUM. PARTE: 2-1645-FD
MARCHA FORD PLATINO 4" MOD II, 12V
AEROSTAR L4 2.3LTS 1986-1987, FAIRMONT
L4 2.3LTS 1981-1983, LTD L4 2.3LTS 1983-1985,
MUSTANG L4 2.3L 1981-1991, RANGER L4 2.3L. Y 2L 13-90,
THUNDERBIRD L4 2.3L 83-88, MERCURY L4 2.3L 81-86,
COUGAR L4 2.3L 1981; 84-86, MARQUIS L4 2.3L 83-85.
LESTER 3191 3175
9 DIENTES

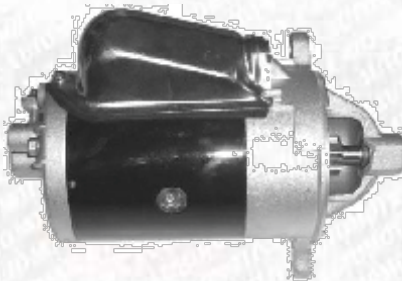

CLAVE: M16483
NUM. PARTE: 2-1648-FD
MARCHA FORD PLATINO 4" MOD II 12V
FORD MARQUIS V6 3.8L Y V8 4.2 Y 5.8L 83-90,
COUGAR V6 Y V8 80-90, LINCOLN TOWNCAR V8 81-89,
CONTINENTAL V8 80-87, THUNDERBIRD V6 Y V8 80-90,
LTD V6 Y V8 80-86, CROWN VICTORIA V8 83-91,
FAIRMONT L6 Y V8 80-83, FORD P-UP L6 Y V8 82-91,
VAN L6 Y V8 83-91 BRONCO L6 Y V8 83-91
9 DIENTES

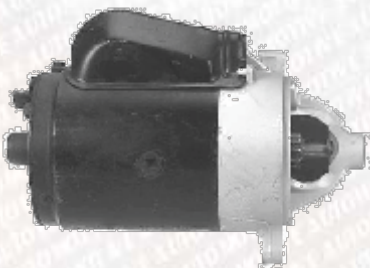

CLAVE: M31743
NUM. PARTE: 2-1664-FD
MARCHA FORD 4 1/2" MOD II, 12 V
BRONCO V8 5.8 Lts 1981, E SERIES VAN V8 5.8 Lts 1981,
E SERIES VAN V8 7.5 Lts, 6.6 Lts 1981-1982,
E SERIES VAN V8 7.5 Lts 1983-1991,
F SERIES PICK UP V8 6.6 Lts, 5.8 Lts 1981,
F SERIES PICK UP V8 6.6 Lts 1982, F SERIES PICK UP
V8 7.5 Lts 1983-1991.
LESTER 3174
9 DIENTES

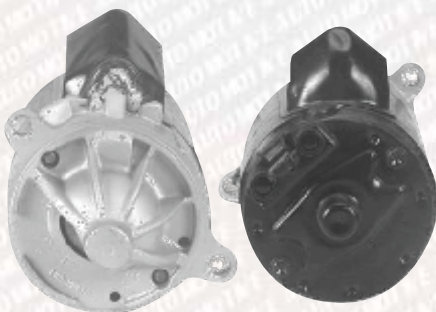

CLAVE: M31697
NUM. PARTE: 2-1665-FD
MARCHA FORD 4 1/2" MOD II, 12 V
FAIRMONT L6 3.3LT 1980-1981,
FAIRMONT L6 3.3L 1983, MUSTANG L6 3.3L 1980-1981,
THUNDERBIRD L6 3.3L 1981,
MERCURY L6 3.3L 1980-1982.
LESTER 3169
9 DIENTES



Marchas Sistema Ford

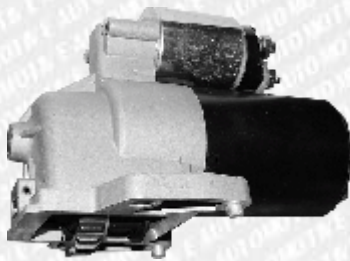

CLAVE: M17194
NUM. PARTE: 2-1719-FD
MARCHA FORD PMOSGR CONTOUR
95-2000 V6 2.5L, ESCAPE 2001 V6 2.5L,
MERCURY COUGAR 99 V6 2.5L,
MYSTIQUE 95-2000 V6 2.5L 12V
LESTER 3263



CLAVE: M17558
NUM. PARTE: 2-1755-FD
MARCHA FORD 1G CONTOUR ESCORT
COUGAR MYSTIQUE 2.0L 95-2000 3262
10 DIENTES



CLAVE: M17561
NUM. PARTE: 2-1648-FD
MARCHA FORD PMGR CONTOUR 95-2000 L4 2L,
FOCUS 2000-2001 L4 2L, COUGAR 99-2001 L4 2L,
MYSTIQUE 95-2000 L4 2L 12V
10 DIENTES 3 OREJAS
LESTER 3261 M21755



CLAVE: M17574
NUM. PARTE: 2-1757-FD
MARCHA FORD PMOSGR 12V FORD
TAURUS 96-99 V6 3L, V8 3.4L,
MERCURY SABLE 96-99 V6 3L. 50-236
22 DIENTES
LESTER 3266

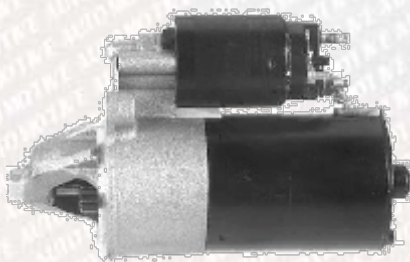

CLAVE: M17996
NUM. PARTE: 2-1799-FD
MARCHA FORD 1G PMGR LINCOLN MERCURY 4.6, 5.4
Y 6.8L 92-2001 CROWN VICTORIA 92-2000 V8 4.6L,
EXPEDITION 97-98 V8 4.6L Y 5.4L, THUNDERBIRD 94-97 V8 4.6L,
TOWN CAR, COUGAR, GRAND MARQUIS 96-2004,
MUSTANG 97-04, E SERIES VAN 97-02, F SERIES PICK UP 97-98,
MARK VIII 97-98, NAVIGATOR 98
12 DIENTES CW
LESTER 3267
DELCO 336-1808



Marchas Sistema Ford



CLAVE: M18009
NUM. PARTE: 2-1800-FD
MARCHA FORD PMGR TAURUS 98-99 V6 3L,
WINDSTAR 96-2003 V6 3.8L, 96-2000 V6 3L,
MERCURY SABLE 98-99 B6 3L
10 DIENTES CW
LESTER 3270
DELCO 336-1194



CLAVE: M18012
NUM. PARTE: 2-1801-FD
MARCHA FORD PMGR 1.4KW 12V FORD
EXPLORER 96-97 V8 5L, MERCURY MOUNTAINEER 97 V8 5L.
10 DIENTES CW
LESTER 3269

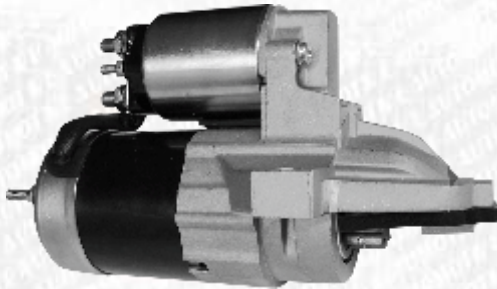

CLAVE: M32572
NUM. PARTE: 32507
MARCHA FORD
PMGR 2000-2007 1S7U-11000-AB,
1S7U-11000-AC, 1S7U-11000-AD,
1.5KW 12V
11 DIENTES



CLAVE: M18025
NUM. PARTE: 2-1802-FD
MARCHA FORD PMGR 1.4KW 12V FORD AEROSTAR 97 V6 4L,
EXPLORER 97 V6 4L, RANGER 97 V6 4L
10 DIENTES CW
LESTER 3271

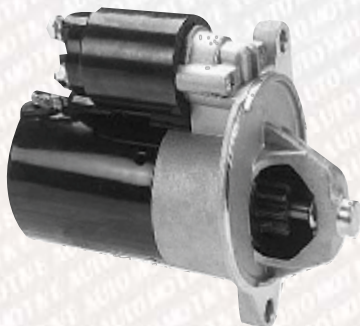

CLAVE: M18067
NUM. PARTE: 2-1806-FD
MARCHA FORD IMANES PMGR BRONCO 92-96, VAN
SERIES E 92-99, PICK-UP SERIES F 92-98, CROWN
VICTORIA 90-91, MUSTANG 92-99, THUNDERBIRD 89-97,
COUGAR 89-97, GRAND MARQUIS 90-91; MARK VII,
TOWN CAR 90-92.
10 DIENTES CW
LESTER 3268 3205 50-216 DELCO 336-1809



Marchas Sistema Ford



CLAVE: M32252
NUM. PARTE: 2-1882-FD
MARCHA FORD PMGR 1.5 KW, 12 V F SERIES PICK UP
V8 7.5 LTS 1992-1997
10 DIENTES CW
LESTER 3225 3246 2-1564-FD
DELCO 336-1169

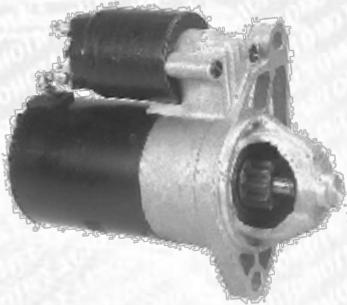

CLAVE: M18843
NUM. PARTE: 2-1884-FD
MARCHA FORD PMGR MARQUIS LINCOLN 4.6L V8 (281)
10 DIENTES CW
LESTER 3242
DELCO 323-516



CLAVE: M18869
NUM. PARTE: 2-1886-FD
MARCHA FORD PMGR 12V AEROSTAR V6 4L
EXPLORER 98-2004 V6 4L RANGER 98-2001 V6 4L
PICK UP 98-99
10 DIENTES
LESTER 3273

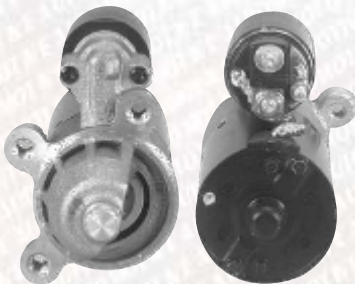

CLAVE: M32720
NUM. PARTE: 2-1887-FD
MARCHA FORD PMGR 12V 10D AEROSTAR V6 3L 1997,
RANGER V6 3L 1998-2001,
MAZDA PICK UP V6 3 L 1998-1999.
10 DIENTES CW
LESTER 3272



CLAVE: M18885
NUM. PARTE: 2-1888-FD
MARCHA FORD PMGR 1.4KW 12V
10 DIENTES CW
LESTER 6645



Marchas Sistema Ford



CLAVE: M18931
NUM. PARTE: 2-1893-FD-1
MARCHA FORD PMGR 12V EXPLORER 97-2001 V8 5L;
MERCURY MOUNTAINEER 97-2001 V8 5L.
10 DIENTES CW
LESTER 3274
DELCO 334-1810



CLAVE: M32400
NUM. PARTE: 2-1895-FD
MARCHA FORD PMGR 12 V EXPLORER V6 4L 97-01,
RANGER V6 4L 98-01,
MAZDA PICK UP V6 4L 98-99.
10 DIENTES CW
LESTER 3240

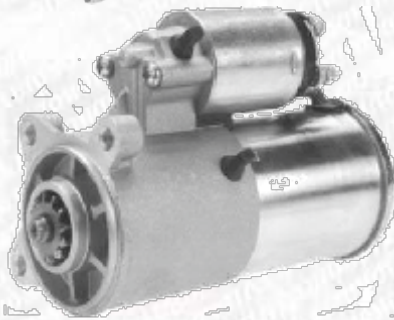

CLAVE: M19103
NUM. PARTE: 2-1910-FD
MARCHA FORD IMANES PMGR 12V LINCOLN NAVIGATOR
V8 5.4L 99-01, P-UP V10 6.8L V8 4.5, 5.4L 99-01,
EXPEDITION V8 4.6L 99-01 FORD EXCURSION V10 6.8L ,
V8 5.4L 99-01, LINCOLN NAVIGATOR 99-2004 V8 5.4L
ECONOLINE TRITON LOBO FORD F-350
LESTER 6646 BENDIX FLOTANTE
12 DIENTES CW
DELCO 336-1937

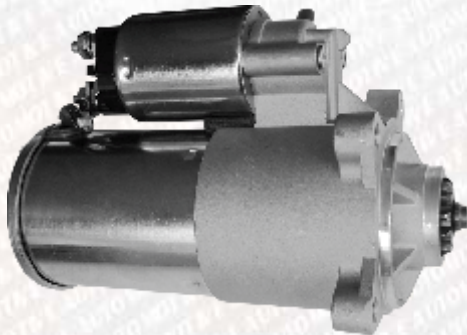

CLAVE: M66582
NUM. PARTE: 6658N
MARCHA NUEVA FORD PMGR 12V
FORD 02-10,
LINCOLN 03-05,
MERCURY 02-10
12 DIENTES

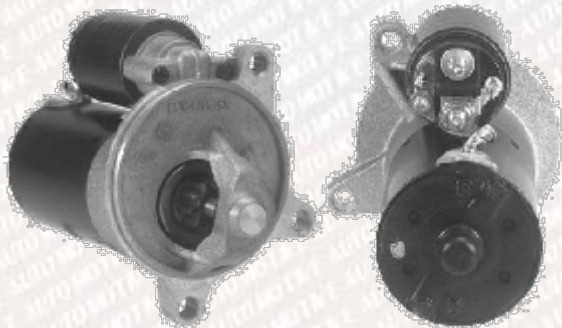

CLAVE: M32311
NUM. PARTE: 2-1914-FD
MARCHA FORD PMGR 12V MUSTANG 92-93 L4 2.3L,
RANGER 91-2001 L4 2.3L, 2.5L; MAZDA PICK UP 94-99 L4 2.3L.
10 DIENTES CW
LESTER 3231 3238 2-1894-FD M18944
DELCO 323-511



Marchas Sistema Ford



CLAVE: M19158
NUM. PARTE: 2-1915-FD
MARCHA FORD PMGR 1.4 KW 12V ESCORT 91-96 L4 1.8L
9 DIENTES CW
LESTER 3214
2-1918-FD-1 M66537



CLAVE: M19554
NUM. PARTE: 2-1955-FD-1
MARCHA FORD PMGR 12V , F SERIES PICK UP 99-2004 V6 4.2L
10 DIENTES CW
LESTER 6647
DELCO 336-1938

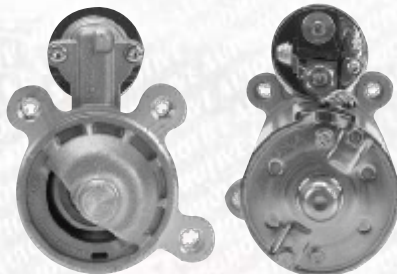

CLAVE: M20301
NUM. PARTE: 2-2030-FD
MARCHA FORD PMGR 1.5KW 12V
FOCUS 2000-2004 L4 2L
10 DIENTES CW
LESTER 6655



CLAVE: M22159
NUM. PARTE: 2-2215-FD
MARCHA FORD OSGR 3.0KW 12V FORD TRITON DIESEL E
SERIES VAN V8 6L 04-06; EXCURSION V8 6L 03-04, V8 7.3L
02-03; F SERIES PICK UP V8 6L 03-05.
12 DIENTES CW
LESTER 6670
SA-904-RM

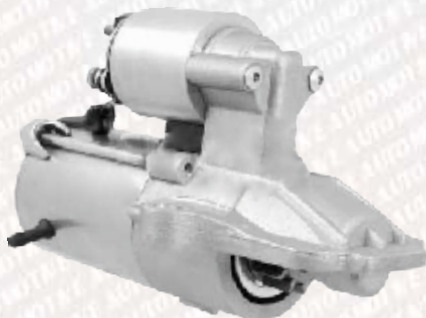

CLAVE: M22408
NUM. PARTE: 2-2400-FD
MARCHA FORD PMGR 12V ESCAPE L4 2.3L 05-08;
FOCUS L4 2.3L 03-07; FOCUS L4 2L 05-08;
MAZDA TRIBUTE L4 2.3L 05-06, 2008;
MERCURY MARINER L4 2.3L 05-08
11 DIENTES CW
LESTER 6674
SA-926 SA-934 SA-963



Marchas Sistema Ford

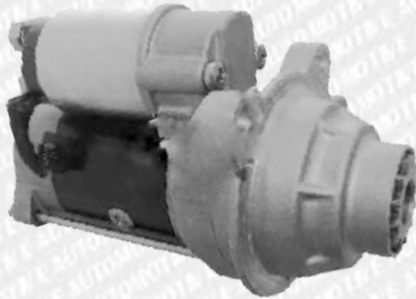

CLAVE: M66756
NUM. PARTE: 6675N
MARCHA NUEVA FORD OSGR 12V
FORD F-250, F-350, F-450, F-550
SUPER DUTY 8 CIL. 6.4L DIESEL 08-10,
FORD VAN E-350 SUPER DUTY 8 CIL. 6.0L
DIESEL 2009
12 DIENTES

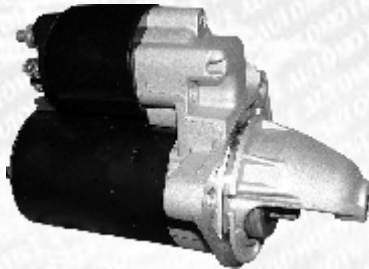

CLAVE: M74178
NUM. PARTE: 0001107417
MARCHA FORD 12V 1.1KW PMGR SISTEMA BOSCH
96FB-11000-KD 31167N-BO
10 DIENTES CW

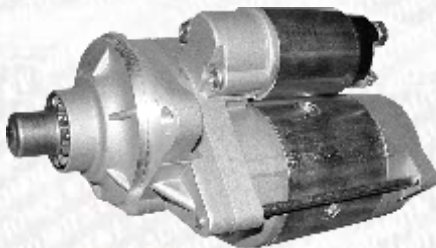

CLAVE: M09039
NUM. PARTE: 2C3Z-11002-AA
MARCHA FORD OSGR TRITON DIESEL F SERIES
PICK UP'S, FORD EXCURSION 02-03 7.3L V8 2-2197-FD
12 DIENTES CW
LESTER 6669

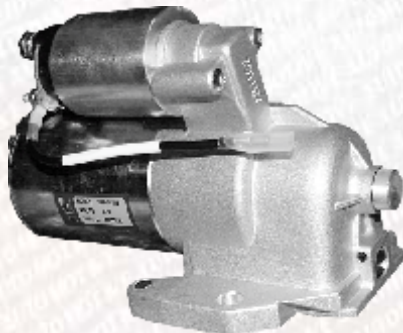

CLAVE: M32645
NUM. PARTE: 2-1712-FD
MARCHA TAURUS PMGR 00-04 V6 3L, MERCURY
SABLE 2000-2004 V6 3L
22 DIENTES CCW
LESTER 3264

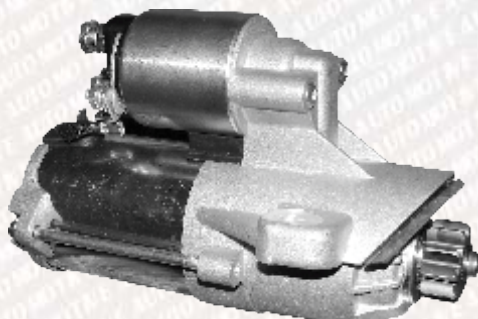

CLAVE: M66920
NUM. PARTE: 6692
MARCHA SISTEMA FORD PMGR 12V **10 DIENTES**
FORD 07-14
LINCOLN 07-14
MERCURY 08-09
FORD EDGE V6 3.5L
LINCOLN MKX V6 3.5L.
8G1T-11000-AA,
8G1Z-11002-A 2-3000-FD



MARCHAS SISTEMAS
HITACHI



Marchas Sistema Hitachi

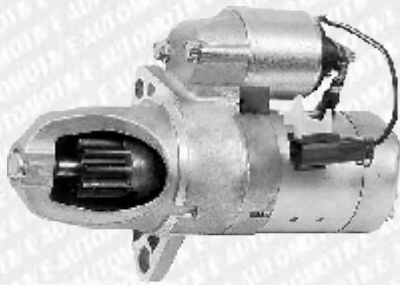

CLAVE: M31014
NUM. PARTE: 23300-31U01
MARCHA HITACHI PMGR 12V
NISSAN MAXIMA 3.0L, 95-2001 V6 3L
2-1856-HI M77135 S114-801B
23300-2Y900 2-2062 17713
NISSAN 063
10 DIENTES



CLAVE: M79115
NUM. PARTE: 2-1107-HI
MARCHA HITACHI PMGR 12V
NISSAN PICK -UP 86-87 V6 3L PATHFINDER 86-89
LESTER 16817 23300-12G02
9 DIENTES

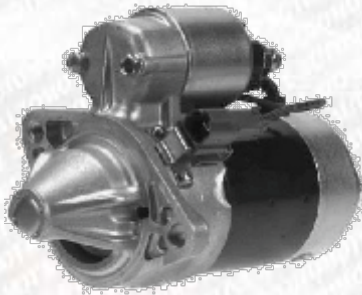

CLAVE: M71461
NUM. PARTE: 2-1117-HI
MARCHA HITACHI PMGR 12V
NISSAN SENTRA 89-99
LESTER 17146
8 DIENTES

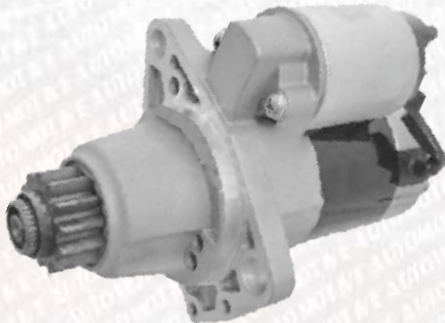

CLAVE: M79803
NUM. PARTE: 17980
MARCHA HITACHI PMGR 1.4KW 12V
NISSAN 02-07. S114-844, S114-844R,
23300-8H00R, 23300-8H300
13 DIENTES

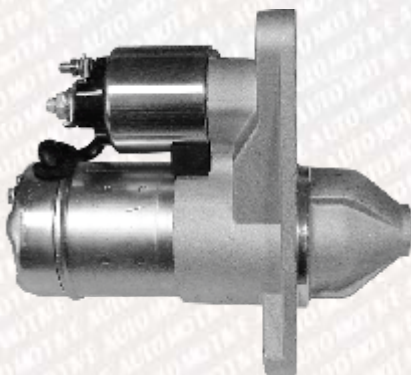

CLAVE: M79829
NUM. PARTE: 17982N
MARCHA NUEVA HITACHI PMGR
NISSAN SENTRA 2.0L 07-10,
NISSAN VERSA 1.8L 07-10 12V
NISSAN 23300-EN200 2-2991-HI
10 DIENTES



Marchas Sistema Hitachi

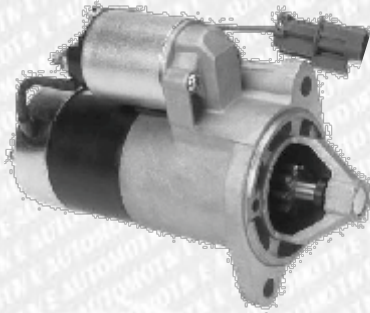

CLAVE: M11227
NUM. PARTE: 2-1122-HI
MARCHA HITACHI 1.2KW 12V
PMGR NISSAN PICK UP 90-95 L4 2.4L
23300-G8400 23300-G8401 S114-527A
LESTER 17454N
9 DIENTES



CLAVE: M71968
NUM. PARTE: 2-1123-HI
MARCHA HITACHI PMGR 1.4 KW, 12 V
NISSAN PATHFINDER V6 3 LTS 1990-1995,
NISSAN PICK UP D21 V6 3 LTS 1990-1995.
LESTER 17196 23300-88G00
9 DIENTES



CLAVE: M17764
NUM. PARTE: 2-1776-HI
MARCHA HITACHI OSGR 2.0KW 12V
THERMOKING CON MOTOR ISUZU
LESTER 18067 45-1263
9 DIENTES



CLAVE: M18960
NUM. PARTE: 2-2233-HI
MARCHA HITACHI OSGR 4.0KW 24V
ISUZU ELF NPR66, NKS58, NKR66 CAMIONES CON
MOTOR DIESEL 4BE1, 4HF1. S25-163A, B, C; 8-97032-464-0,
8-97032-464-2, 8-97065-526-0
LESTER 18960.
11 DIENTES



CLAVE: M16805
NUM. PARTE: 16805
MARCHA NISSAN PICK-UP 720 2.4 L, 2.2L.,
2L 81-89 DATSUN 510, 610, 710 80-83 16711
2-1086-HI 23300-W0402



Marchas Sistema Hitachi



CLAVE: M74300
NUM. PARTE: 23300-74Y00
MARCHA NUEVA JAPONESA DD NISSAN TSURU III,
SENTRA 91-96 STANDARD 17147
S01-04N
8 DIENTES CCW
LESTER 17147

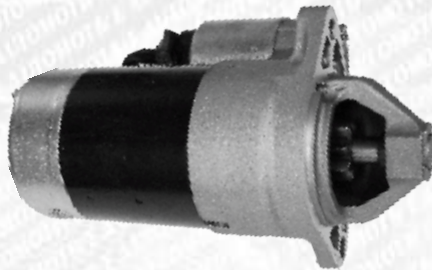

CLAVE: M01428
NUM. PARTE: 23300-F4201
MARCHA RECO EN JAPON NISSAN SENTRA GS 96-98
T/BOSCH
60004AA0009

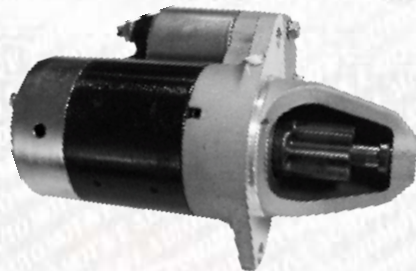

CLAVE: M80005
NUM. PARTE: 23300-M8000
MARCHA RECO EN JAPON NISSAN DD TSURU I Y TSURU II
ESTÁNDAR 84-91
8 DIENTES CCW
LESTER 16775
S01-02R



CLAVE: M81011
NUM. PARTE: 23300-M8101
MARCHA RECO EN JAPON NISSAN OSGR TSURU I Y II
AUTOMATICA 84-91, SENTRA L4 1.5L 82,
SENTRA L4 1.6L 83-84 12V
21 DIENTES CCW
LESTER 16732
16918 2-1092-HI

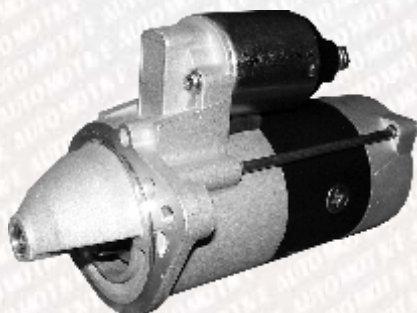

CLAVE: M01022
NUM. PARTE: 23300-U0102
MARCHA RECO EN JAPON NISSAN DD PICK UP
520, 620, 720 70-80 DATSUN 68-79
9 DIENTES CW
LESTER 16203



Marchas Sistema Hitachi



CLAVE: M30842
NUM. PARTE: 23300-G8400
MARCHA RECO EN JAPON NISSAN
D21 PICK UP 4 CIL 90-95 AUTOMATICA 17454

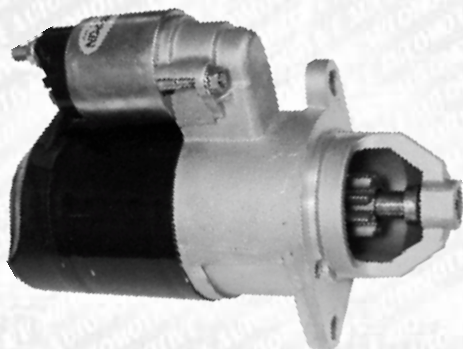

CLAVE: M00105
NUM. PARTE: 23300-B5000
MARCHA RECO EN JAPON DATSUN SEDAN 67-84
PICK UP 520 620 65-69
23300-B5000



MARCHAS SISTEMA
HYUNDAI

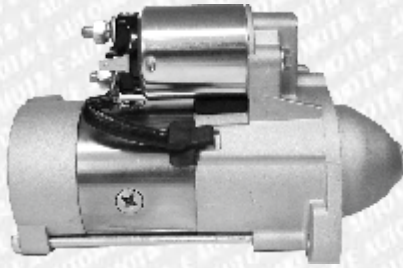

Marchas Sistema Hyundai

CLAVE: M28102

NUM. PARTE: 36100-42350

MARCA DODGE HYUNDAI OSGR H100 DIESEL 12V 2.2KW
36100-4A000

10 DIENTES CW

2008 =>



**MARCHAS SISTEMA
ISKRA**



Marchas Sistema Iskra



CLAVE.M81957
NUM. PARTE: 18195
MARCHA ISKRA DD 12V 3.1KW
JOHN DEERE 97-05
10 DIENTES
6651258
6651664
RE105298
RE501767
RE60239
RE70728



**MARCHAS SISTEMA
LUCAS**



Marchas Sistema Lucas



CLAVE: M50920
NUM. PARTE: 50-9200
MARCHA MOTOR LUCAS DD SERIES M127 12V
TRACTOR FORD SM-1305
10 DIENTES CW
LESTER 16608



CLAVE: M12085
NUM. PARTE: SM-1208-A
MARCHA PERKINS LUCAS DD SERIES M50 12V
MASSEY FERGUSON 2-2290-LU
10 DIENTES CW
LESTER 16670 ST-1062
2-2290-LU

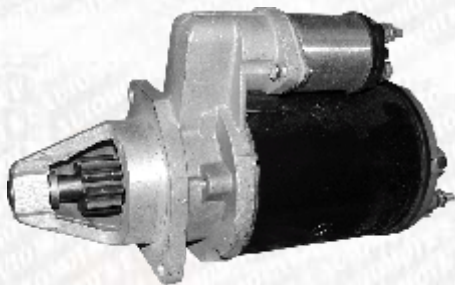

CLAVE: M13105
NUM. PARTE: 2-2303-LU
MARCHA MOTOR LUCAS DD SERIES M50 12V CASE,
IHC, MASSEY FERGUSON, TRACTORES 30REJAS
10 DIENTES CW
LESTER 16984
26336 26433 27575 SM1310



MARCHAS SISTEMA
MARELLI



Marchas Sistema Marelli

CLAVE: M18944
NUM. PARTE: 18940
MARCHA MARELLI PLGR 12V 3.0KW
PERKINS 2004-2010 7169477, 7169479,
DENSO 428000-1290,
JCB 71440231, 71440531, 63280041,
MSN8041, 2873K405, 2873K634
10 DIENTES



**MARCHAS SISTEMA
MITSUBA**



Marchas Sistema Mitsuba



CLAVE: M21198
NUM. PARTE: 2-1019-MT
MARCHA MITSUBA PMGR 12V 1.6KW
HONDA ACCORD 2.2L (90-95) ODYSSEY 95 2.2L,
PRELUDE 2.2/2.3L (92-96)
HONDA 31200-P13-903, -904, -905;
31200-PT0-900, -903, -905, -906;
MITSUBA SM402-03, -15, -15N
LESTER 16960
9 DIENTES CW



CLAVE: M28376
NUM. PARTE: 2-2837-MT
MARCHA MITSUBA PMGR 1.6KW 12V
HONDA CR-V 2.4L (02-06)
LESTER 17844 HONDA 31200PPA-A01, -A02;
MITSUBA SM612-06
9 DIENTES CW



CLAVE: M78708
NUM. PARTE: 17870N
MARCHA NUEVA MITSUBA 12V
ACURA TSX 2.4L 04-05,
HONDA ACCORD 2.4L 03-05,
HONDA ELEMENT 2.4L 03-06 ,
2-2685-MT
9 DIENTES

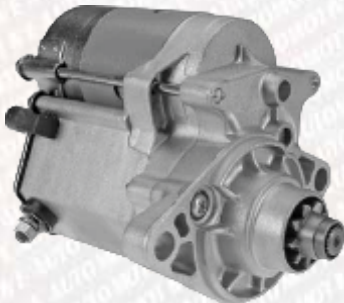

CLAVE: M69130
NUM. PARTE: 16913N
MARCHA MITSUBA OSGR 1.0KW/12 VOLT,
HONDA CIVIC 1.3L, 1.5L, 1.6L 84-95,
HONDA CIVIC DEL SOL 1.5L, 1.6L 93-95,
HONDA CRX 1.3L, 1.5 84-91
2-1012-ND-2
9 DIENTES CW

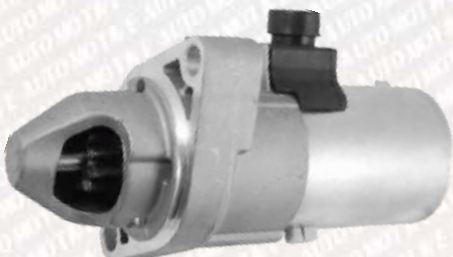

CLAVE: M79600
NUM. PARTE: 17960N
MARCHA MITSUBA PMGR 12V
ACURA CSX 2.0L 06-08,
ACURA TSX 2.4L 06-08,
HONDA ACCORD 2.4L 06-07,
HONDA CIVIC 2.0L 06-09,
HONDA CR-V 2.4L 07-09,
HONDA ELEMENT 2.4L 07-08
2-2850-MT



MARCHAS SISTEMA
MITSUBISHI



Marchas Sistema Mitsubishi

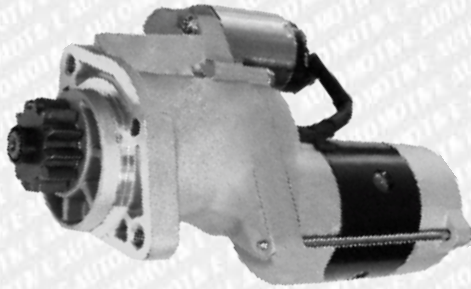

CLAVE: M23574
NUM. PARTE: 23300-VM00A
MARCHA NUEVA MITSUBISHI OSGR 12V
NISSAN PICK UP FRONTIER,
NISSAN KING CAB, PICK-UP D22 2.5L DIESEL
12 DIENTES 2 OREJAS
M002T50575
32715N



CLAVE: M69929
NUM. PARTE: 16992
MARCHA NUEVA HITACHI/MITSUBISHI DD 0.8KW 12V
NISSAN PICKUP 2.4L 88-95,
NISSAN VAN 2.4L 87-89
8 DIENTES M3T38482



CLAVE: M78724
NUM. PARTE: 17872N
MARCHA MITSUBISHI PMGR 12V
NISSAN 04-09 MITSUBISHI M0T20771, M0T20771ZC,
NISSAN 23300-8Y000, 23300-8Y00A
11 DIENTES

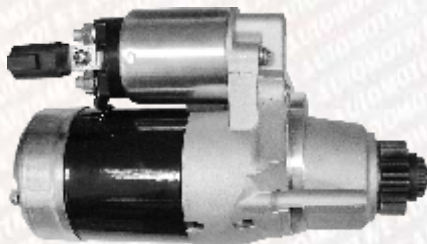

CLAVE: M78357
NUM. PARTE: 2-2343-MI
MARCHA MITSUBISHI PMGR 1.4KW/12V,
NISSAN ALTIMA 2.5L W/ AT 02-07,
NISSAN SENTRA 2.5L W/ AT 02-06 17835N
13 DIENTES CCW

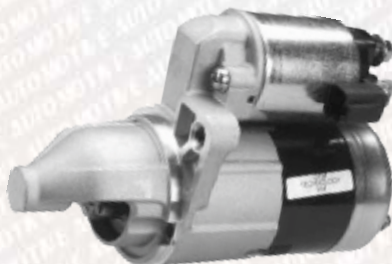

CLAVE: M19364
NUM. PARTE: 17740N
MARCHA MITSUBISHI PMGR 12V,
NISSAN ALTIMA 2.4L 98-00
23300-9E010 2-1936-MI
8 DIENTES CW



Marchas Sistema Mitsubishi

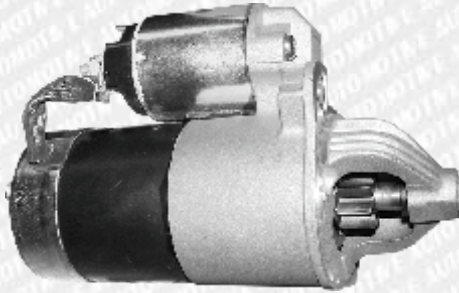

CLAVE: M77750
NUM. PARTE: 17775N
MARCHA MITSUBISHI PMGR 1.2KW/12V,
MITSUBISHI MONTERO 3.0L 00-03,
MITSUBISHI MONTERO 3.5L 99-04,
MITSUBISHI MONTERO 3.8L 03-06
8 DIENTES CW
2-2021-MI

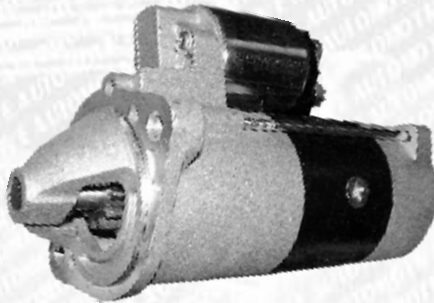

CLAVE: M32366
NUM. PARTE: 32367N
MARCHA MITSUBISHI 2.2KW 12V PLGR MITSUBISHI
L300 TRUCK 4D56 2.5 DIESEL 88-12,
L300 TRUCK 4D56 2.5L TURBO DIESEL 94-01,
MONTERO 4D56 2.5L DIESEL 91-99,
MONTERO 4D56 2.5L TURBO DIESEL 91-99
M002T84071, M002T87071, MD312857, Md312858
10 DIENTES

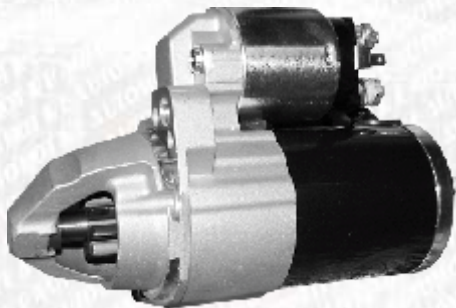

CLAVE: M90372
NUM. PARTE: 19037N
MARCHA OUTLANDER, LANCER 4 CIL.
MITSUBISHI PMGR 12V.
MITSUBISHI 08-11
MITSUBISHI M0T21571
8 DIENTES



CLAVE: M78298
NUM. PARTE: 17829
MARCHA MITSUBISHI PMGR
CHRYSLER 2001-2008. 5033067A 12V
9 DIENTES



CLAVE: M78826
NUM. PARTE: 17882N
MARCHA MITSUBISHI PMGR 12V.
JEEP 03-05 CHRYSLER
56041641AD, 56041641AF, 56041641AG
10 DIENTES



Marchas Sistema Mitsubishi

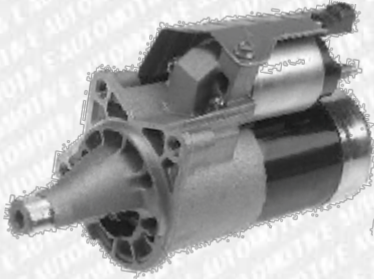

CLAVE: M19509
NUM. PARTE: 2-1950-MI
MARCHA MITSUBISHI PMGR 12V
CHRYSLER CONCORDE 98-2001 V6 2.7L;
DODGE INTREPID 98-2001 V6 2.7L
STRATUS CIRRUS 95-99 4609058 M00585
LESTER 17726 17559
10 DIENTES

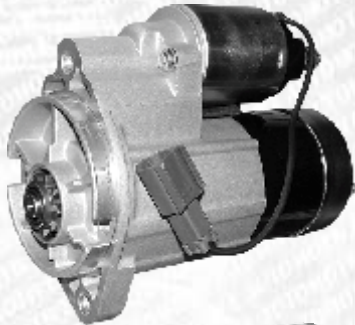

CLAVE: M29788
NUM. PARTE: 2-1978-MI
MARCHA MITSUBISHI PMGR NISSAN FRONTIER
3.3L 99-01; X-TERRA 3.3L 00-01; M0T60186,
M0T60187 23300-4S100
LESTER 17738
9 DIENTES

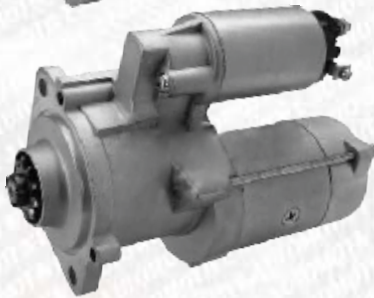

CLAVE: M81636
NUM. PARTE: 2-2102-MI
MARCHA MITSUBISHI OSGR 2.2KW 12V LIFT
TRUCKS CON S4E, S4S MOTOR DIESEL
103-9827 32A66-00100
LESTER 18163
10 DIENTES

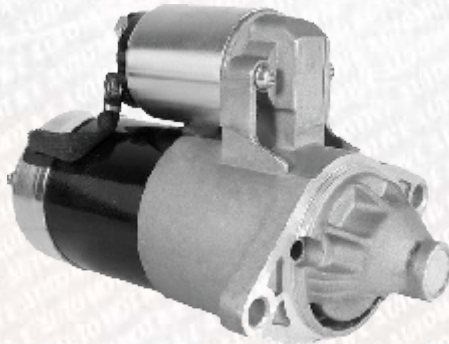

CLAVE: M21215
NUM. PARTE: 2-2121-MI
MARCHA MITSUBISHI PMGR 12V CHEVROLET
TRACKER 2.0L TRANSMISION AUTOMATICA
2000-2003; SUZUKI VITARA 2.0L TRANSMISION
AUTOMATICA 2000-2003
8 DIENTES 30024597 M1T85881
LESTER 17836N

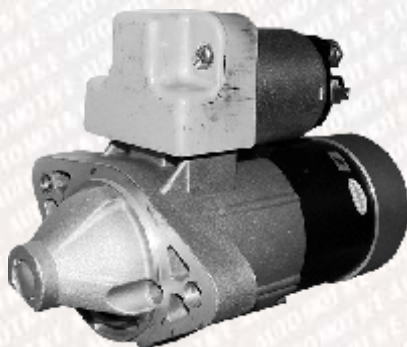

CLAVE: M77836
NUM. PARTE: 2-1991-MI
MARCHA MITSUBISHI PMGR 12V CHEVROLET
TRACKER 1.6L 99-00; TRACKER 2.0L 1999;
SUZUKI GRAND VITARA 2.5, 2.7L 99-05; VITARA 1.6L 99-02;
VITARA 2.0L 99-00; XL-7 2.7L 2005.
LESTER 17783
8 DIENTES
30020753, M0T85881.

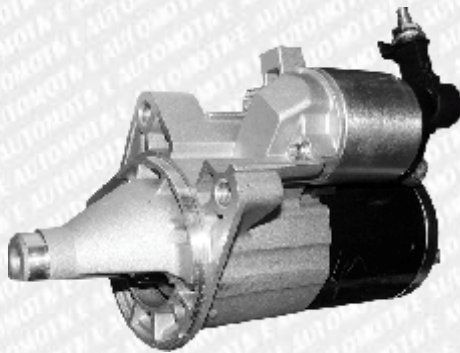

Marchas Sistema Mitsubishi

CLAVE: M88009
NUM. PARTE: 04608800AE
MARCHA MITSUBISHI PMGR 12V CHRYSLER PACIFICA
4.0L 07-08; SEBRING 2.7L Y 3.5L 07-09;
TOWN & COUNTRY VAN 4.0L 08-09;
DODGE AVENGER 2.7, 3.5L 08-09; CARAVAN 4.0L 08-09;
JOURNEY 3.5L 2009.
10 DIENTES M0T32371
LESTER 19026

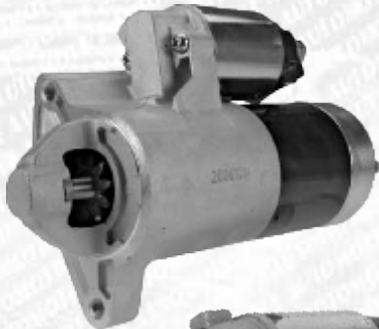

CLAVE: M78779
NUM. PARTE: 17877N
MARCHA MITSUBISHI PMGR 12 VOLT,
JEEP LIBERTY 3.7L 2002 2-2342-MI
10 DIENTES CW

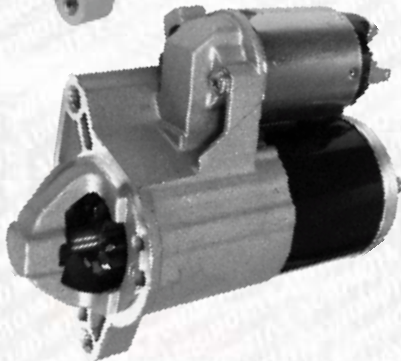

CLAVE: M79410
NUM. PARTE: 17941
MARCHA MITSUBISHI 12V JEEP GRAND CHEROKEE
V8 6.1L 2006-2008 5030023AA
M0T21971ZC



CLAVE: M79481
NUM. PARTE: 17948
MARCHA MITSUBISHI PMGR 1.4KW 12V
DODGE 09-14; JEEP 09-14; RAM 11-14.
56044736AC, R6044736AC, M000T23271ZC
10 DIENTES

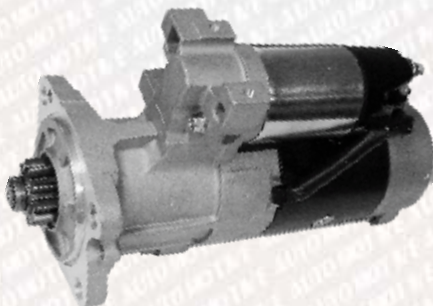

CLAVE: M60378
NUM. PARTE: M8T60371
MARCHA MITSUBISHI PLGR 24V
5.0KW MONTACARGAS DIESEL DP40 / 50K/KL FD35D
S6E/S6S; FD-35DA S6E /S6S; FD-38 S6E / S6S;
FD-40D S6E/ S6S. MOTOR 55.3KW CAPACIDAD 4000 Y 5000
KG; ELF400 30KW 12V M8T60372 32B66-00200 103-312
LESTER 18246
10 DIENTES



Marchas Sistema Mitsubishi

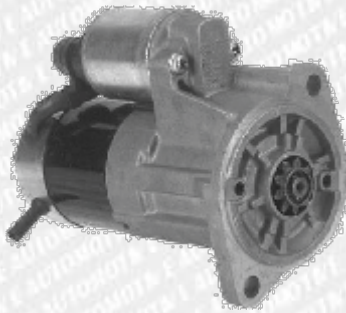

CLAVE: M11214
NUM. PARTE: 2-1121-MI
MARCHA MITSUBISHI PMGR 1.4KW
12V NISSAN PICK UP 90-95 L4 2.4L
LESTER 17425
9 DIENTES



CLAVE: M11285
NUM. PARTE: 2-1128-MI
MARCHA IMPORTACION MITSUBISHI PMGR 12V
NISSAN SENTRA 91-2001 L4 2L 1.8L TM
INFINITI G20 91-99 L4 2L, NISSAN 200SX L4 2L,
NISSAN NX 91-93 L4 2L,
LESTER 17246 17745 23300-63J00, 23300-63J01
8 DIENTES

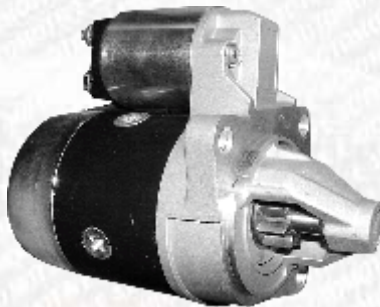

CLAVE: M21418
NUM. PARTE: 2-1141-MI
MARCHA MITSUBISHI DD 0.85KW 12V MAZDA 626,
PICK UP 2.0L 83-87. F601-18-400, 400A;
M3T30285 LESTER 16859
8 DIENTES

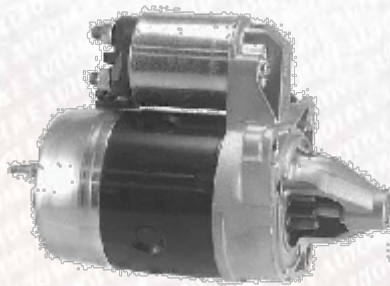

CLAVE: M69228
NUM. PARTE: 2-1144-MI
MARCHA MITSUBISHI 0.85 KW, 12 V
MAZDA, MERCURY.
LESTER 16922
8 DIENTES

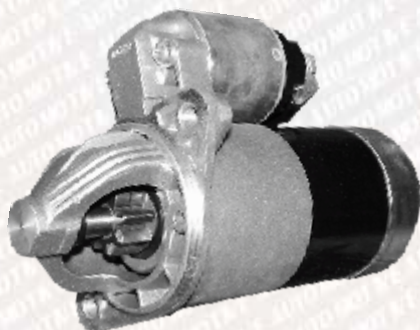

CLAVE: M11488
NUM. PARTE: 2-1148-MI
MARCHA MITSUBISHI 1.4KW 12V PMGR
MAZDA PICK UP 87-88 L4 2.6L
LESTER 17185 0986016001
8 DIENTES



Marchas Sistema Mitsubishi

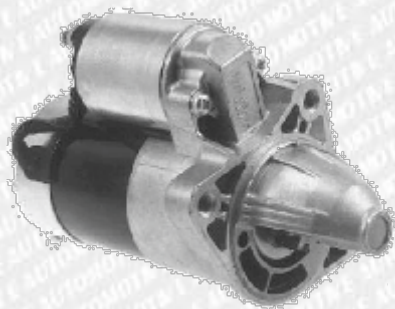

CLAVE: M69333
NUM. PARTE: 2-1152-MI
MARCHA MITSUBISHI PMGR 1.4 KW,
12 V MAZDA PICK UP L4 2.2L 88-93.
LESTER 16933
10 DIENTES



CLAVE: M11665
NUM. PARTE: 2-1166-MI
MARCHA MITSUBISHI DD 0.7-0.9KW 12V
DODGE RAM 50 PICK UP 87-89 L4 2L, 90-93 L4 2.4L;
MITSUBISHI PICK UP 87-89 L4 2L 90-96 L4 2.4L
LESTER 16729 16940
8 DIENTES

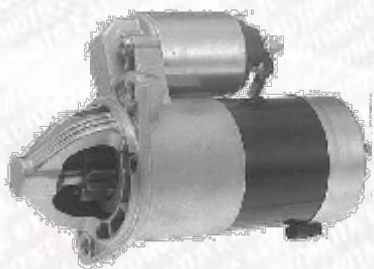

CLAVE: M69391
NUM. PARTE: 2-1174-MI
MARCHA MITSUBISHI PMGR 1.2 KW, 12V
DODGE, EAGLE, HYUNDAI, MITSUBISHI,
PLYMOUTH LESTER 16939
8 DIENTES



CLAVE: M12321
NUM. PARTE: 2-1232-MI
MARCHA MITSUBISHI PMGR 1.7KW 12V
JEEP CHEROKEE 87-98 L6 4L; GRAND CHEROKEE
92-98 L6 4L; GRAND WAGONEER 88-91 V8 5.9L;
WAGONEER 87-90 L6 4L;
WRANGLER 88-90 L6 4.2L Y 91-98 L6 4L.
LESTER 17006
10 DIENTES

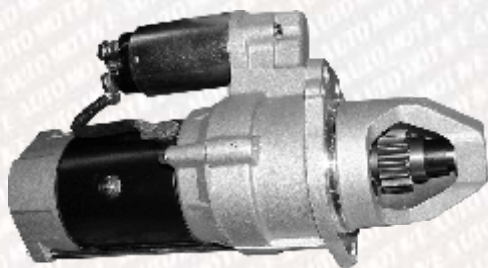

CLAVE: M12540
NUM. PARTE: 2-1254-MI
MARCHA MITSUBISHI OSGR 3.6KW 12V
FORD SERIES E, F VAN PICK UP 6.9L (DIESEL) 85-87;
FORD SERIES E, F VAN, PICK UP 7.3L (DIESEL) 88-94.
13 DIENTES
LESTER 17037N E8TF-11000-AA,
E8TZ-11002-A; M3T90071, M3T90072



Marchas Sistema Mitsubishi



CLAVE: M74371
NUM. PARTE: 2-1444-MI-9
MARCHA MITSUBISHI PMGR 12V 1.2KW NISSAN
LIFT TRUCK, TMC LIFT TRUCKS
9 DIENTES LESTER 17437 M1T60081,
M1T60381, 23300-K9160, 23300-W9810



CLAVE: M15477
NUM. PARTE: 2-1547-MI
MARCHA MITSUBISHI PMGR 12V
JEEP GRAND CHEROKEE 93-98 V8 5.2L; 98 V8 5.9L.
LESTER 17467
10 DIENTES

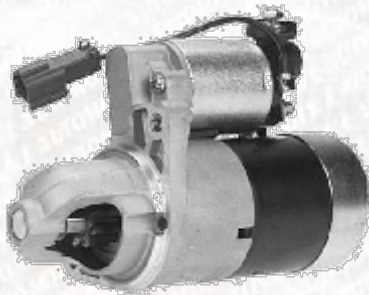

CLAVE: M74780
NUM. PARTE: 2-1611-MI
MARCHA MITSUBISHI PMGR 12 V
NISSAN ALTIMA L4 2.4 LTS 1993-1997.
LESTER 17478
8 DIENTES



CLAVE: M16120
NUM. PARTE: 2-1612-MI
MARCHA MITSUBISHI OSGR 1.2KW 12V CLARK,
MITSUBISHI LIFT TRUCK CON MOTOR 4G33 4G52 4G54
11 DIENTES LESTER 17110

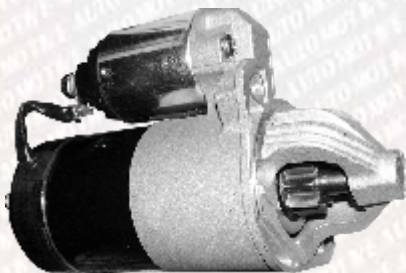

CLAVE: M11766
NUM. PARTE: 2-1176-MI
MARCHA
MITSUBISHI DODGE RAM 50 PICKUP 3.0L 90-91,
MITSUBISHI GALANT 3.0L 1988,
MITSUBISHI MONTERO 3.0L 89-99,
MITSUBISHI MONTERO 3.5L 94-98,
MITSUBISHI PICKUP 3.0L 90-94,
MITSUBISHI SIGMA 3.0L 89-90
17131N



Marchas Sistema Mitsubishi



CLAVE: M79334
NUM. PARTE: 17933N
MARCHA MITSUBISHI PMGR 1.7/12 VOLT,
DODGE RAM PICKUP 5.7L W/ AT 05-08
10 DIENTES CW
2-2697-MI

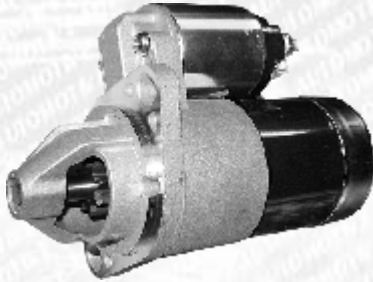

CLAVE: M17283
NUM. PARTE: 2-1728-MI
MARCHA MITSUBISHI DD 0.8KW 12V EATON, HYSTER,
SUMITOMO YALE, TCM, YALE LIFT TRUCKS CON
MOTOR MAZDA 1362069 FESE-18-400
LESTER 16924 **8 DIENTES**



CLAVE: M47173
NUM. PARTE: 2-1747-MI
MARCHA MITSUBISHI FORD P-UP VAN V8 7.3L
IMPORTACION
LESTER 17577
12 DIENTES



CLAVE: M17486
NUM. PARTE: 2-1748-MI
MARCHA MITSUBISHI PLGR 12V FORD
EXCURSION 7.3L 2000; SERIES E VAN 7.3L 95-2000;
SERIES F PICK UP 7.3L POWER STROKE DIESEL.
F4TZ-11002-A; M8T50071 LESTER 17578.
12 DIENTES.

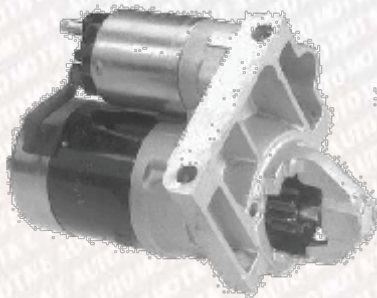

CLAVE: M17824
NUM. PARTE: 2-1782-MI
MARCHA MITSUBISHI PMGR 12V
DODGE, DAKOTA 96-98 L4 2.5L;
JEEP CHEROKEE 94-98 L4 2.5L;
WRANGLER 94-98 L4 2.5L.
LESTER 17564 M77383 4796981
10 DIENTES



Marchas Sistema Mitsubishi



CLAVE: M27109
NUM. PARTE: 23300-AC100
MARCHA MITSUBISHI PMGR 12V NISSAN
FRONTIER 98-2001 L4 2.4L, PICK UP 96-97 L4 2.4L,
XTERRA 00-01 L4 2.4L; URVAN
9 DIENTES LESTER 17685
23300-1S770 S01-27N 2-1847-MI M18476



CLAVE: M66714
NUM. PARTE: MOT36671
MARCHA NISSAN
CABSTAR 2.5L 2008
URVAN 2.5L 08-09.



CLAVE: M23021
NUM. PARTE: 2300-VW20B
MARCHA NUEVA MITSUBISHI
NISSAN URVAN
DIESEL 2.5L
9 DIENTES

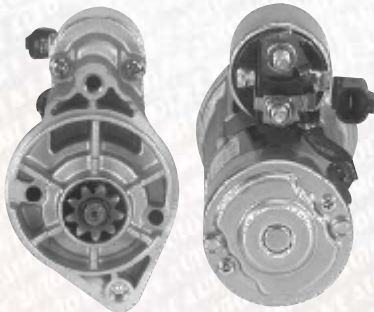

CLAVE: M76833
NUM. PARTE: 2-1848-MI
MARCHA MITSUBISHI PMGR 1.4 KW, 12 V
NISSAN INFINITI V6 3.3 LTS 1997-2000, PATHFINDER
V6 3.3 LTS 1996-2000.
LESTER 17683 23300-0W010
9 DIENTES



CLAVE: M77401
NUM. PARTE: 2-1852-MI
MARCHA MITSUBISHI DD 1.0KW 12V
NISSAN FRONTIER 98-99 L4 2.4L;
PICK UP 96-97 L4 2.4L
LESTER 17684
8 DIENTES



Marchas Sistema Mitsubishi



CLAVE: M18640
NUM. PARTE: 2-1864-MI
MARCHA MITSUBISHI PMGR 1.2KW 12V
NISSAN 200 SX 95-98 L4 1.6L;
SENTRA 95-99 L4 1.6L
LESTER 17688 23300-0M210
8 DIENTES

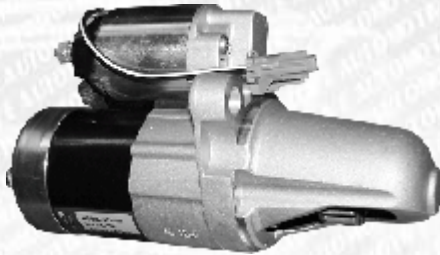

CLAVE: M78302
NUM. PARTE: 17830N
MARCHA MITSUBISHI PMGR 1.4KW/12 VOLT,
NISSAN ALTIMA, MAXIMA 3.5L W/ MT 02-07
12 DIENTES CCW
2-2717-MI-2

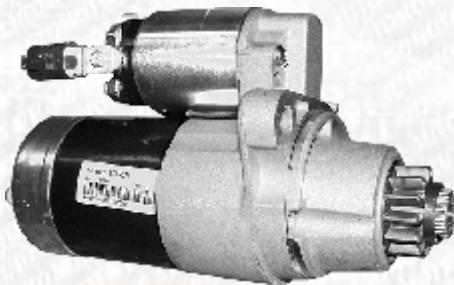

CLAVE: M78636
NUM. PARTE: 17863N
MARCHA MITSUBISHI PMGR 1.7/12 VOLT,
NISSAN MAXIMA 3.5L 07-08,
NISSAN MURANO 3.5L 03-07
13 DIENTES CCW
2-2691-MI



CLAVE: M78331
NUM. PARTE: 17833N
MARCHA MITSUBISHI PMGR 1.4KW/12 VOLT,
NISSAN ALTIMA 2.5L W/ MT 02-07,
NISSAN SENTRA 2.5L W/ MT 02-06
13 DIENTES CCW
2-2779-MI

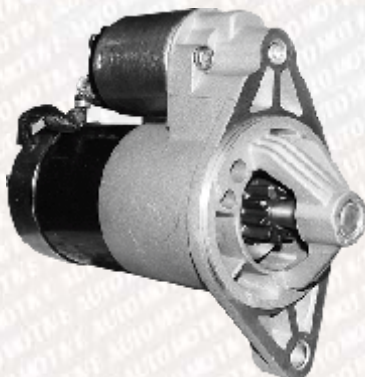

CLAVE: M19669
NUM. PARTE: 2-1966-MI
MARCHA MITSUBISHI PMGR 12V JEEP
CHEROKEE 99-2001 L6 4L, GRAND CHEROKEE 99-2002 L6 4L,
WRANGLER 99-2002 L6 4L
LESTER 17749
10 DIENTES



Marchas Sistema Mitsubishi

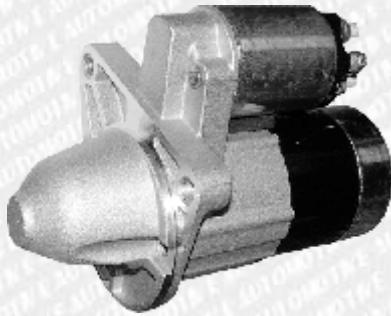

CLAVE: M79436
NUM. PARTE: 17943
MARCHA MITSUBISHI PMGR 1.4KW 12V
NISSAN 05-13; SUZUKI 09-12. 23300-EA000,
SUZUKI 31100-82Z00, 31100-82Z01
11 DIENTES

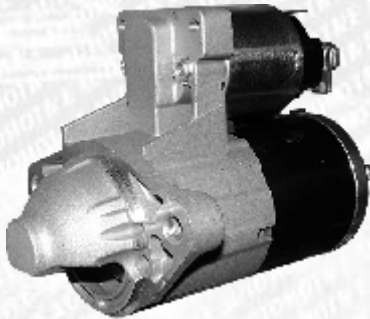

CLAVE: M90575
NUM. PARTE: 19057
MARCHA MITSUBISHI PMGR 1.4KW 12V
SUZUKI 2006-2008. 31100-65J30, 31100-65J30
8 DIENTES

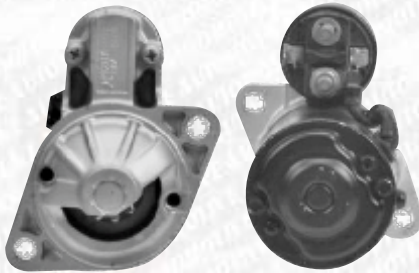

CLAVE: M19963
NUM. PARTE: 2-1996-MI
MARCHA MITSUBISHI PMGR 1.2 KW 12V
CATERPILLAR LIFT TRUCKS
LESTER 17176
10 DIENTES



CLAVE: M20879
NUM. PARTE: 2-2087-MI
MARCHA MITSUBISHI OSGR 5.0 KW 24V
CATERPILLAR, MITSUBISHI MONTACARGAS CON
MOTOR S4E, S4S, S6S.
10 DIENTES
LESTER 18239



CLAVE: M23849
NUM. PARTE: 2-2384-MI
MARCHA MITSUBISHI PMGR 12V 1.4KW
NISSAN ALTIMA 3.5L 02-04; MAXIMA 3.5L 04-06;
QUEST 3.5L 04-06. TRANSMISION AUTOMATICA
11 DIENTES M0T87187 23300-8J120
LESTER 17831N



Marchas Sistema Mitsubishi



CLAVE: M23881
NUM. PARTE: 2-2388-MI
MARCHA MITSUBISHI PMGR 1.4KW 12V
NISSAN FRONTIER V6 3.3L 02-04; X-TERRA V6 3.3L 02-04.
11 DIENTES
LESTER 17859N M0T87481 23300-4S103



CLAVE: M15185
NUM. PARTE: AM15-18-400A
MARCHA RECO EN JAPON PICK UP PMGR B2600
2.6L 87-88
8 DIENTES CW
LESTER 17185



CLAVE: M90635
NUM. PARTE: 19063
MARCHA NUEVA MITSUBISHI PMGR 1.7KW 12V
INFINITI 2013; NISSAN 07-13.
23300-JA10A, 23300-JA10AR, 23300-JA10C
13 DIENTES

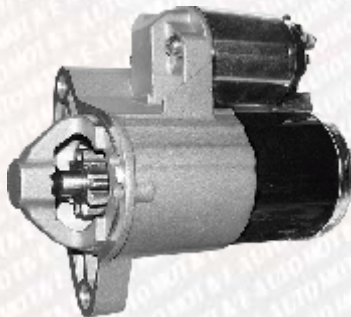

CLAVE: M23925
NUM. PARTE: 2-2392-MI
MARCHA MITSUBISHI PMGR 1.2KW 12V
JEEP COMMANDER 4.7L 06-08; GRAND CHEROKEE
4.7L 05-08; LIBERTY 3.7L 06-07 56044735AB
LESTER 17937 **10 DIENTES.**



CLAVE: M78491
NUM. PARTE: 17849N
MARCHA MITSUBISHI PMGR 12 VOLT,
CHRYSLER PT CRUISER 2.4L 03-09
9 DIENTES CW
2-2653-MI



Marchas Sistema Mitsubishi

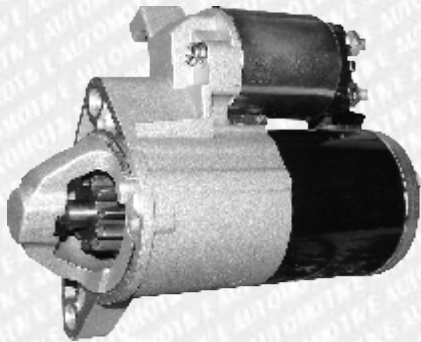

CLAVE: M26616
NUM. PARTE: 2-2661-MI
MARCHA MITSUBISHI PMGR 1.2KW 12V
JEEP COMMANDER 3.7L 06-09; GRAND
CHEROKEE 3.7L 05-09;
10 DIENTES
LESTER 17939N 56044734AA; M0T31471.



CLAVE: M26776
NUM. PARTE: 2-2677-MI
MARCHA MITSUBISHI PMGR 1.4KW 12V
NISSAN FRONTIER, X-TERRA 2.4L 2002-2004
10 DIENTES LESTER 17861
M0T87381 23300-9Z400



CLAVE: M79318
NUM. PARTE: 2-3009-MI
MARCHA NUEVA MITSUBISHI PMGR
1.4 KW 12 VOLT, ECLIPSE
2.4L 06-09, MITSUBISHI GALANT 2.4L 04-09,
MITSUBISHI LANCER, OUTLANDER 2.4L 04-06
LESTER 17931N M0T20672
8 DIENTES



CLAVE: M23529
NUM. PARTE: 32352
MARCHA NUEVA MITSUBISHI PLGR
FORD RANGER 2.5L 99 ==>
FORD F8RU-11000-AA, F8RU-11131-CA;
MAZDA WL91-18-400;
MITSUBISHI M2T87271



CLAVE: M77966
NUM. PARTE: 2-2033-MI
MARCHA NUEVA MITSUBISHI PMGR
CHRYSLER SEBRING 01-05,
DODGE STRATUS 2.4L SOHC 01-05,
MITSUBISHI ECLIPSE 2.4L 00-05,
MITSUBISHI GALANT 2.4L 99-03,
MITSUBISHI OUTLANDER 2.4L (2003)
MITSUBISHI M1T84883, M1T84884;
MITSUBISHI MOTORS MD356178, MD362910
LESTER 17796



Marchas Sistema Mitsubishi



CLAVE: M28920
NUM. PARTE: 2-2892-MI
MARCHA MITSUBISHI PMGR 12V 1.0KW
NISSAN ALTIMA 2001 L4 2.4L
LESTER 17828 M0T86685
11 DIENTES

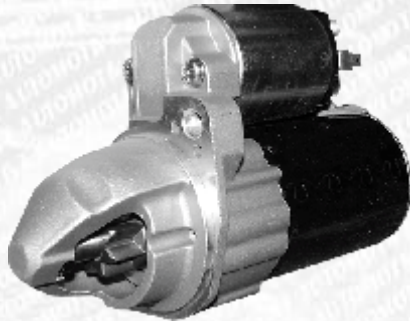

CLAVE: M34552
NUM. PARTE: 2-3018-MI
MARCHA MITSUBISHI PMGR 12V 1.2KW
CHRYSLER SEBRING 2.4L 07-09;
DODGE AVENGER 2.4L 08-09; CALIBER 1.8, 2.0, 2.4L 07-09;
JOURNEY 2.4L 2009; JEEP COMPASS 2.0, 2.4L, 07-09;
PATRIOT 2.0, 2.4L 07-09.
8 DIENTES
LESTER 17994 M0T32071 05034555AA



CLAVE: M28389
NUM. PARTE: MD162838
MARCHA RECO EN JAPON DD MITSUBISHI MIRAGE,
DODGE, EAGLE, HYUNDAI, PLYMOUTH 91-97 12V
8 DIENTES CW
LESTER 17288
2-1183-MI



CLAVE: M17719
NUM. PARTE: 2-1771-MI
MARCHA MITSUBISHI PMGR 12V CHRYSLER
CIRRUS 95-00 V6 2.5L; SEBRING 96-00 V6 2.5L;
DODGE STRATUS 95-00 V6 2.5L.
10 DIENTES CW
LESTER 17559 DELCO 336-1626 4609058

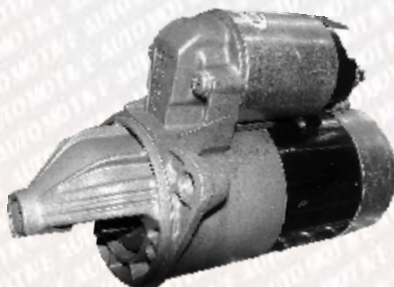

CLAVE: M96675
NUM. PARTE: MD099667
MARCHA RECO EN JAPON MITSUBISHI PMGR
PICK UP 2.0L 83-89 STANDARD
9 DIENTES CW
LESTER 16939



Marchas Sistema Mitsubishi



CLAVE: M10021
NUM. PARTE: XF5Z11002AAR
MARCHA MITSUBISHI PMGR 12V NISSAN QUEST 3L,
MERCURY VILLAGER, MAXIMA
13 DIENTES CCW
LESTER 17479 M1T64285, 2-1772-MI-2



CLAVE: M00657
NUM. PARTE: 23300-65Y00
MARCHA RECO EN JAPON PMGR NISSAN TSURU III,
SENTRA 89-99 AUTOMATICO
8 DIENTES CW
LESTER 17146



CLAVE: M18405
NUM. PARTE: F802-18-400
MARCHA RECO EN JAPON MAZDA PICK UP DD
B2000 2.0L 86-87 STANDARD 0.85KW 12V
8 DIENTES CW 3 OREJAS
LESTER 16859
F601-18-400



CLAVE: M20840
NUM. PARTE: F240-18-400
MARCHA RECO EN JAPON MAZDA PICK UP DD
B2200 2.2L 88-89 STANDARD
8 DIENTES CW
LESTER 16922

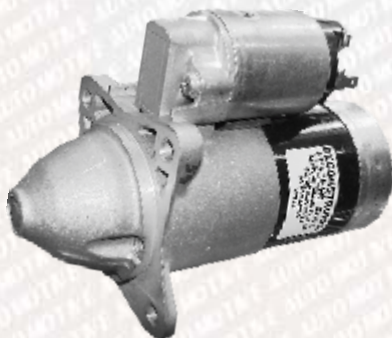

CLAVE: M21489
NUM. PARTE: F214-18-400
MARCHA RECO EN JAPON MAZDA PICK UP
PMGR B2200 2.2L 88-93 AUTOMATICO
10 DIENTES CW
LESTER 16933



Marchas Sistema Mitsubishi



CLAVE: M33078
NUM. PARTE: 33307N
MARCHA SISTEMA MITSUBISHI PLGR 12V
NISSAN 05-10
RENAULT 97-2013
11 DIENTES
M008T76071
23300-EB300
23300-EB30A
23300-EB30B



**MARCHAS SISTEMA
NIPPONDENSO**



Marchas Sistema Nippondenso



CLAVE: M78459
NUM. PARTE: 17845N
MARCHA IMPORTACION DENSO 12V
ACURA EL 1.7L 01-03,
HONDA CIVIC 1.7L 01-05
9 DIENTES



CLAVE: M76158
NUM. PARTE: 17615
MARCHA NIPPONDENSO OSGR CATERPILLAR
CHALLENGER 35, 45, TRACTORES FARM
W/ 3114, 3116, MOTORES MARINOS
CATERPILLAR 12V
10 DIENTES

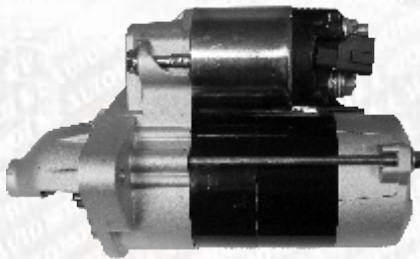

CLAVE: M75197
NUM. PARTE: 28100-75190
MARCHA NUEVA NIPPONDENSO PMGR
12V TOYOTA HIACE 4 CIL. 2.7 LTS. 06-09
9 DIENTES

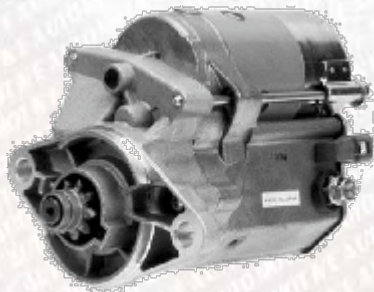

CLAVE: M67379
NUM. PARTE: 2-1034-ND
MARCHA NIPPONDENSO OSGR 1.0 kW, 12 V
TOYOTA L4 2.4 LTS. 1981-1993; 4RUNNER, CELICA,
CORONA, PICK UP 81-93.
LESTER 16737
9 DIENTES



CLAVE: M78230
NUM. PARTE: 17823N
MARCHA DENSO OSGR 12 VOLT,
DODGE DAKOTA, DURANGO 3.7L 04-05,
DODGE DAKOTA 4.7L 02-05,
DODGE DURANGO 4.7L 02-03,
DODGE RAM PICKUP 3.7L, 4.7L 02-05,
DODGE RAM PICKUP 5.7L 2003
10 DIENTES CW
2-2327-ND



Marchas Sistema Nippondenso

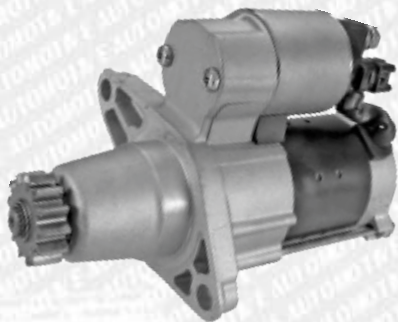

CLAVE: M78256
NUM. PARTE: 17825N
MARCHA NUEVA NIPPONDENSO PMGR 12V.
TOYOTA CAMRY 2.4L, 3.0L 02-05,
TOYOTA HIGHLANDER 2.4L 04-06,
TOYOTA SOLARA 2.4L 02-06,
TOYOTA RAV4 2.4L, 3.5L 06-08,
TOYOTA SIENNA 3.3L 04-06,
TOYOTA SIENNA 3.5L 07-09
28100-28040, 28100-28041 2-2212-ND
13 DIENTES

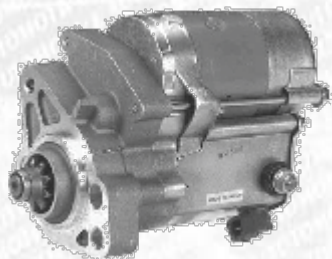

CLAVE: M74209
NUM. PARTE: 2-1059-ND
MARCHA NIPPONDENSO OSGR 1.0 kW,
12V TOYOTA PICK UP V6 3LT 1988-1991
LESTER 17420
9 DIENTES



CLAVE: M11930
NUM. PARTE: 2-1193-ND
MARCHA NIPPONDENSO OSGR 2.0KW 12V
CHEVROLET LUV PICK UP 81-82 L4 2.2L;
GMC, CHEV SERIES S, T PICK UP 84 Y 85 L4 2.2L;
ISUZU PICK UP 81-87 L4 2.2L;
TROOPER 86-87 L4 2.2L. 94123387
LESTER 16739N
9 DIENTES

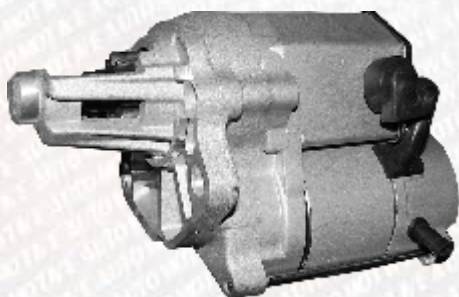

CLAVE: M13981
NUM. PARTE: 2-1398-ND
MARCHA NIPPONDENSO 1.4KW 12V
DODGE B SERIES VAN 91-95 V6 3.9L, 91-95 V8
5.2L Y 5.9L; DAKOTA 91-95 V6 3.9L Y 91-95 V8 5.2L;
RAM PICK UP 94-95 V6 3.9L, V85.2L Y 5.9L;
RAM CHARGER 91-93 V8 5.2L, 91-93 V8 5.9L.
RAM CHARGER CORTA
LESTER 17466
10 DIENTES



CLAVE: M15261
NUM. PARTE: 2-1526-ND
MARCHA NIPPONDENSO OSGR
2.5KW 12V CASE, FORD, TRACTOR,
CUMMINS 3.9L, 5.9L MOTOR DIESEL
LESTER 16990 17390
13 DIENTES



Marchas Sistema Nippondenso

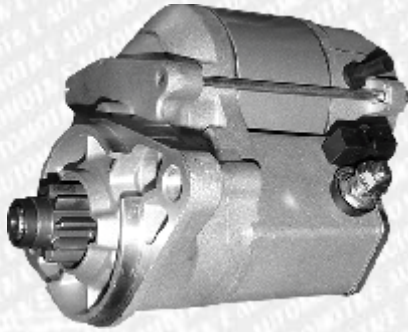

CLAVE: M16146
NUM. PARTE: 2-1614-ND
MARCHA NIPPONDENSO OSGR 1.4KW 12V
TOYOTA 4 RUNNER 92-93 L4 2.4L,
PICK UP 92-93 L4 2.4L
LESTER 16831
9 DIENTES

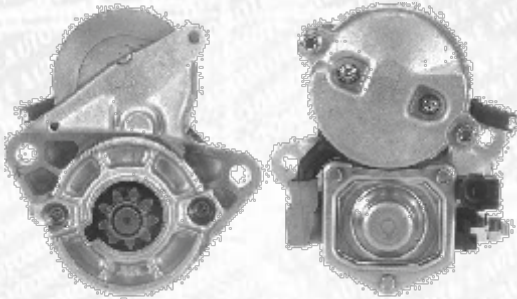

CLAVE: M75361
NUM. PARTE: 2-1698-ND
MARCHA NIPPONDENSO OSGR 1.2 KW,
12 V TOYOTA P-UP L4 2.7L 94-98.
LESTER 17536
9 DIENTES

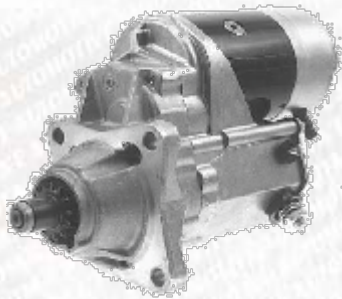

CLAVE: M17267
NUM. PARTE: 2-1726-ND
MARCHA NIPPONDENSO OSGR
FORD 7.3L,CUMMINS, BOBCAT, DIESEL,
RETROEXCAVADORA CASE 2.5KW 12V
13 DIENTES LESTER 16658

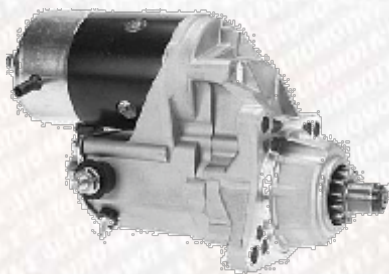

CLAVE: M17397
NUM. PARTE: 2-1739-ND
MARCHA NIPPONDENSO OSGR 2.7KW
12V DODGE RAM PICK UP 94-2000 L6 5.9L
LESTER 17548
13 DIENTES

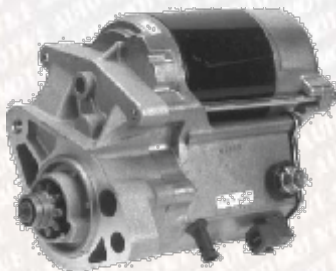

CLAVE: M19015
NUM. PARTE: 2-1901-ND
MARCHA NIPPONDENSO OSGR
1.4 KW 12V TOYOTA P-UP V6 3L
1988-1993. LESTER 17125
9 DIENTES



Marchas Sistema Nippondenso



CLAVE: M13819
NUM. PARTE: 2-1381-ND
MARCHA WAI NIPPONDENSO CHRYSLER
LEBARON 82-85 L4 2.6 L DODGE
NEW YORKER 83-85 L4 2.6L
11 DIENTES 12V 1.2KW



CLAVE: M13835
NUM. PARTE: 2-1383-ND
MARCHA NIPPONDENSO SERIES
VAN V8 V6 5.2L, 5.9L 3.9L, PICK-UP 88-95
V8, V6 5.9L, 3.9L, 5.2L DAKOTA V6 3.9L
RAM CHARGER V8 5.2L RAM LARGA
10 DIENTES 17084

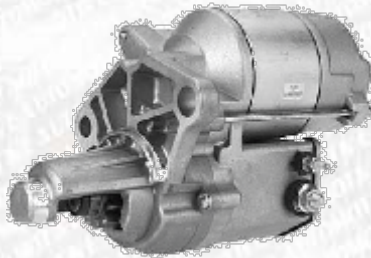

CLAVE: M18070
NUM. PARTE: 2-1807-ND
MARCHA WAI NIPPONDENSO
DODGE VAN V6, V8 3.9L, 5.2L. RAM PICK UP V8,
V6 96-98 5.2L, 3.9L DURANGO V8 1998.
DAKOTA 96-98 RAM CHARGER CORTA
10 DIENTES



CLAVE: M18374
NUM. PARTE: 2-1837-ND
MARCHA DENSO OSGR
TOYOTA 4RUNNER 3.4L W/ MT 96-01,
TOYOTA T100 PICKUP 3.4L 95-98,
TOYOTA TACOMA 3.4L 95-04,
TOYOTA TUNDRA 3.4L 00-04
17671N

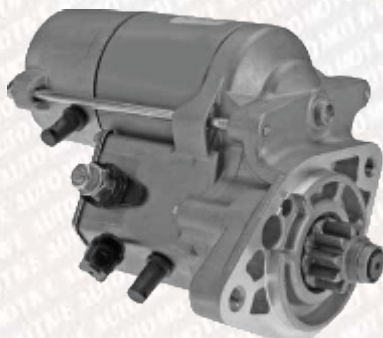

CLAVE: M78766
NUM. PARTE: 17876
MARCHA DENSO OSGR 2.0KW 12V
TOYOTA 03-10. 428000-1250,
TOYOTA 28100-31050, 28100-31050-84
10 DIENTES



Marchas Sistema Nippondenso

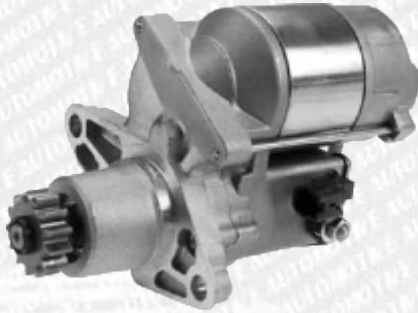

CLAVE: M75345

NUM. PARTE: 17534N

MARCHA DENSO OSGR 1.4KW/12 VOLT,
LEXUS ES300 3.0L 95-96,
TOYOTA AVALON 3.0L 95-96,
TOYOTA CAMRY 2.2L, 3.0L 95-96,
TOYOTA CELICA 2.2L 94-99,
TOYOTA RAV4 2.0L 96-00

13 DIENTES CCW

2-1834-ND



CLAVE: M77747

NUM. PARTE: 17774N

MARCHA NUEVA DENSO OSGR 1.4KW 12V
LEXUS ES300 3.0L 98-01,
LEXUS RX300 3.0L 99-03,
TOYOTA AVALON 3.0L 98-04,
TOYOTA CAMRY 2.2L, 3.0L 98-01,
TOYOTA HIGHLANDER 2.4L, 3.0L 01-03,
TOYOTA RAV4 2.4L 04-05,
TOYOTA RAV4 2.0L 01-03,
TOYOTA SIENNA 3.0L 98-03,
TOYOTA SOLARA 3.0L 99-03,
TOYOTA SOLARA 2.2L 99-01

13 DIENTES

28100-03100



CLAVE: M77852

NUM. PARTE: 17785N

MARCHA DENSO OSGR 12V DODGE 99-09, MITSUBISHI 06-09
BOSCH 6-004-AA4-000
LESTER 17787, 17894

10 DIENTES



CLAVE: M79508

NUM. PARTE: 17950N

MARCHA DENSO PLGR 12 VOLT, DODGE DAKOTA 3.7L,
4.7L 06-09, DODGE DURANGO 3.7L 06-09, DODGE RAM
PICKUP 3.7L, 4.7L 06-09, MITSUBISHI RAIDER 3.7L 06-09,
MITSUBISHI RAIDER 4.7L 06-07

9 DIENTES CW

2-3019-ND

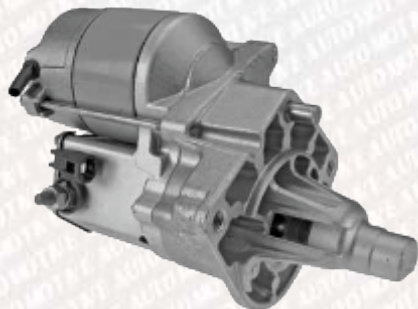

CLAVE: M71971

NUM. PARTE: 17197N

MARCHA DENSO OSGR 1.4KW/12 VOLT,
CHRYSLER FIFTH AVENUE 3.3L, 3.8L 90-92,
CHRYSLER IMPERIAL 3.3L, 3.8L 90-92,
CHRYSLER NEW YORKER 3.3L 90-92,
CHRYSLER TOWN & COUNTRY VAN 3.3L 90-92,
DODGE CARAVAN 3.3L 90-92,
PLYMOUTH VOYAGER 3.3L 90-92

11 DIENTES CW

2-1382-ND-2



Marchas Sistema Nippondenso

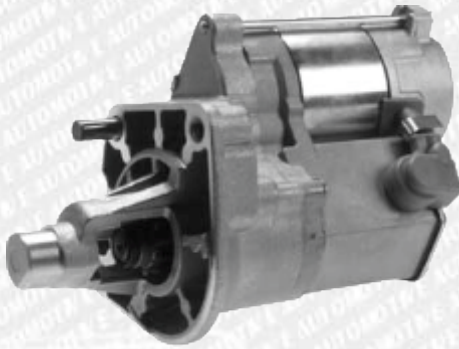

CLAVE: M74650

NUM. PARTE: 17465

MARCHA DENSO OSGR 1.2KW 12V

CHRYSLER 93-99; DODGE 92-99.

0-001-108-123, 4686045, 4686109,

4686109E, 228000-0470, 228000-0471,

228000-0472, 228000-0473

10 DIENTES

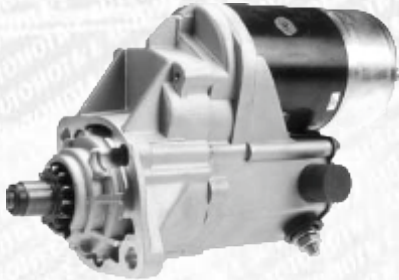

CLAVE: M73628

NUM. PARTE: 17362N

MARCHA DENSO OSGR 2.7KW 12V

BOBCAT 74-90; CLARK 74-90; JOHN DEERE 87-07;

SUBARU 84-03; SULLAIR 97-03.

13 DIENTES



CLAVE: M73919

NUM. PARTE: 17391

MARCHA DENSO OSGR 5.5KW 24V

CASE 84-00; SAMSUNG 92-98.

1987566C1, D129494, 128000-2560,

128000-2561, 128000-2562,

128000-2563

10 DIENTES

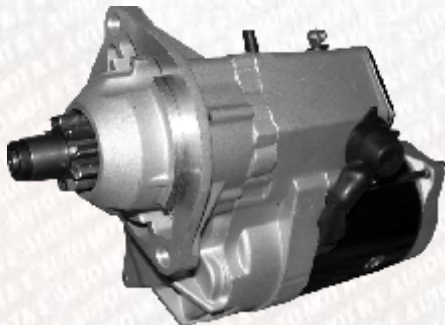

CLAVE: M76161

NUM. PARTE: 17616N

MARCHA DENSO OSGR 5.5KW 24V

CATERPILLAR 89-98.

7C5731, 8C4774, 9W3748,

DENSO 128000-5730, 128000-5731,

128000-5732, 128000-5733

10 DIENTES

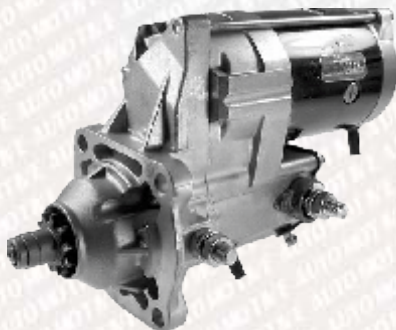

CLAVE: M61617

NUM. PARTE: 17616N

MARCHA DENSO OSGR 5.5KW 24V

CATERPILLAR 89-98. 7C5731, 8C4774, 9W3748,

DENSO 128000-5730, 128000-5731,

128000-5732, 128000-5733

11 DIENTES



Marchas Sistema Nippondenso



CLAVE: M84065
NUM. PARTE: 18406
MARCHA DENSO OSGR 4.0KW 12V
INTERNATIONAL 88-07.
228000-8510, TG228000-8510
10 DIENTES

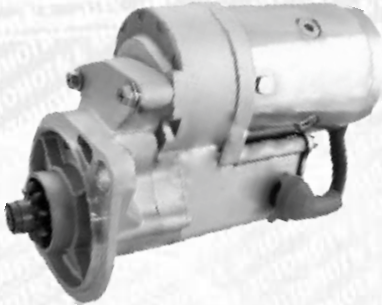

CLAVE: M89817
NUM. PARTE: 18981N
MARCHA DENSO 2.2KW 12V OSGR
MASSEY FERGUSON 04-06
428000-2650 600-863-1410
9 DIENTES



CLAVE: M22031
NUM. PARTE: 2-2203-ND
MARCHA DENSO OSGR 2.0KW 12V
HYSTER LIFT TRUCK CON MOTOR GM V6 4.3L.
10 DIENTES
LESTER 18198 28000-586



CLAVE: M23604
NUM. PARTE: 2-2360-ND-2
MARCHA DENSO PMGR 12V PONTIAC
VIBE 1.8L 03-08; TOYOTA COROLLA,
MATRIX 1.8L 03-08; 428000-034; 28100-0D080
LESTER 17841

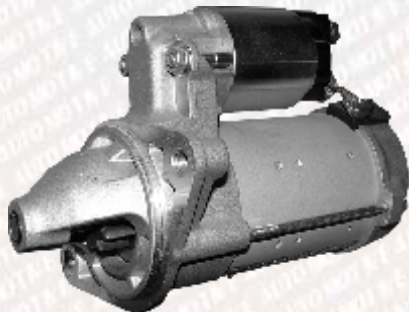

CLAVE: M19495
NUM. PARTE: 19049
MARCHA NUEVA DENSO PMGR 1.6KW 12V
PONTIAC VIBE L4 1.8L 09-10,
TOYOTA COROLLA L4 1.8L 2011,
COROLLA L4 1.8L VIN L 09-10, VIN U 2009,
MATRIX L4 1.8L VIN U 09-11
428000-4300, 428000-4590, 88975514,
28100-0T050, 28100-37050
9 DIENTES



Marchas Sistema Nippondenso



CLAVE: M24551
NUM. PARTE: 2-2455-ND
MARCHA NIPPONDENSO OSGR 2.7KW 12V
DODGE RAM PICK UP L6 5.9L 03-06
13 DIENTES
LESTER 17892N

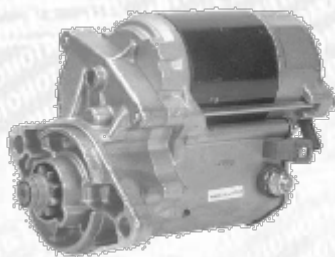

CLAVE: M10240
NUM. PARTE: 28100-34053
MARCHA RECO EN JAPON NIPPONDENSO OSGR 1.4KW
12V TOYOTA CELICA 81-83 L4 2.4L; PICK UP 81-83 L4 2.4L
9 DIENTES CW
LESTER 16674
2-1024-ND



CLAVE: M75070
NUM. PARTE: 28100-75070
MARCHA RECO EN JAPON NIPPONDENSO OSGR 1.0KW
12V TOYOTA TACOMA 95-96 L4 2.4L
9 DIENTES CW
LESTER 17666
2-1831-ND 2-1832-ND

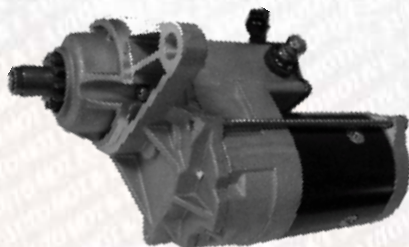

CLAVE: M89729
NUM. PARTE: 8972077862
MARCHA SISTEMA NIPPONDENSO OSGR 3KW 12V
CAMIONES CHEVROLET W3500, 4500, 5500,
ISUZU, GMC, MOTORES DIESEL 3.9/4.8L,
11 DIENTES CCW
LESTER 18500 22800081-80, -81, -82



CLAVE: M34084
NUM. PARTE: 28100-34080
MARCHA RECO EN JAPON TOYOTA OSGR PICK UP
2.4L 81-95 CELICA CORONA 12V
9 DIENTES CW
LESTER 16737
2-1034-ND-2



Marchas Sistema Nippondenso



CLAVE: M75139
NUM. PARTE: 28100-75130
MARCHA RECO EN JAPON OSGR T-100
PICK UP 2.7L 94-96
9 DIENTES CW
LESTER 17536



CLAVE: M78386
NUM. PARTE: 17838N
MARCHA MITSUBISHI PMGR 12 VOLT,
CHEVROLET TRACKER 2.5L 01-04,
SUZUKI VITARA 2.5L 2004
8 DIENTES CW
2-2119-MI-2



**MARCHAS SISTEMA
PRESTOLITE**



Marchas Sistema Prestolite

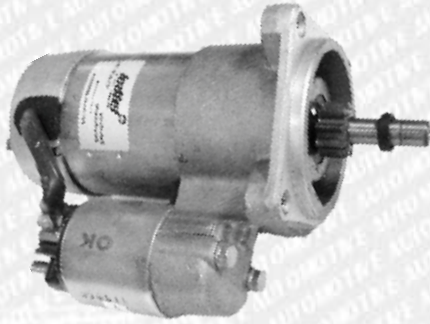

CLAVE: M87402
NUM. PARTE: 35258740AM
MARCHA PRESTOLITE VW POINTER 1997-2001,
OPCION 2002-2003 12V
9 DIENTES CW

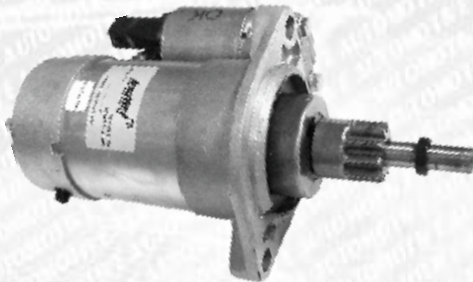

CLAVE: M90606
NUM. PARTE: 35259060AM
MARCHA PRESTOLITE VW DERBY 2000-2003,
POINTER 2002-2007 12V
10 DIENTES CCW

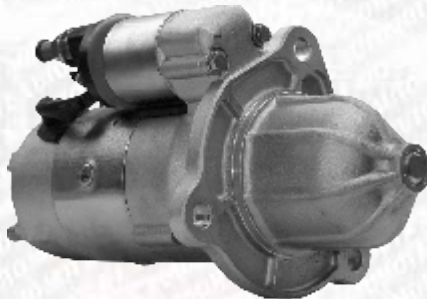

CLAVE: M97302
NUM. PARTE: 35259730S
MARCHA PRESTOLITE INTERNATIONAL M100R
12V 4KW CAMION MOTOR NAVISTAR DT-466,
I6 7.6L 2002-2003
12 DIENTES CW
(3574173C91)

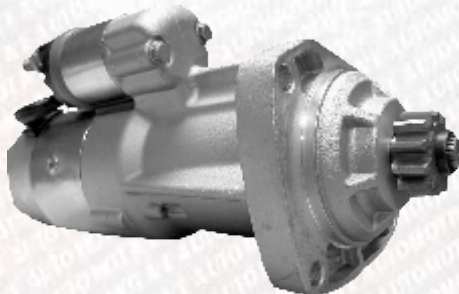

CLAVE: M35264
NUM. PARTE: 35261680S
MARCHA PRESTOLITE INTERNATIONAL M100R 12V 3KW
MOTOR NAVISTAR 6.0L 2002-2007 (3571513C92)
11 DIENTES CW

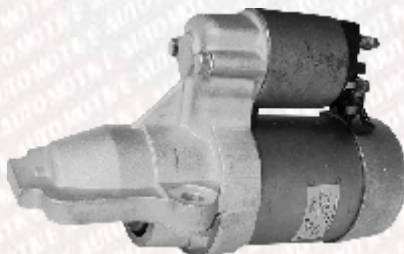

CLAVE: M52619
NUM. PARTE: 35261260
MARCHA REMANUFACTURADA
(SISTEMA PRESTOLITE ARGENTINA)
FORD PMGR 12V RANGER L4 2.3L 01-08;
MAZDA PICK UP L4 2.3L 01-08
LESTER 6657N SA-987 1L5T-11000-AA
11 DIENTES PRESTOLITE 35261260

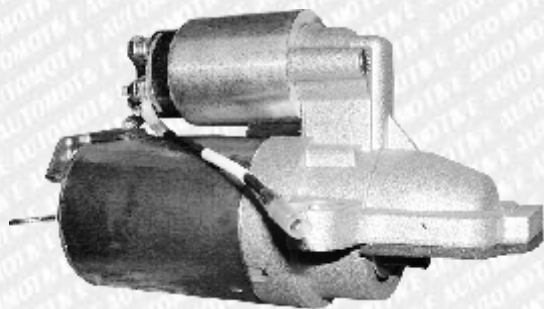

Marchas Sistema Prestolite

CLAVE: M22188

NUM. PARTE: 2-2218-FD

MARCHA FORD PMGR 12V RANGER L4 2.3L 01-08;

MAZDA PICK UP L4 2.3L 01-08

11 DIENTES CW

LESTER 6657N

SA-987 1L5T-11000-AA



MARCHAS SISTEMA
VALEO



Marchas Sistema Valeo



CLAVE: M30708
NUM. PARTE: TM000A37001SP
MARCHA VALEO HYUNDAI .08KW 12V
8 DIENTES CW
LESTER 32453 438101,
36100-02511



CLAVE: M81230
NUM. PARTE: 438123
MARCHA VALEO 2KW 12V H100 2.5L, HYUNDAI
AUTOBUS (93-94) FURGON (94-00)
MITSUBISHI L200 Y L300 DOHC 4CIL
10 DIENTES CW
LESTER 16853, 33038
TM000-A06101, -V36101; 36100-42-010, -350;
MD164975



CLAVE: M80764
NUM. PARTE: 558076
MARCHA VALEO
HYUNDAI TERRACAN 3.5 V6 4WD 01-06,
KIA SORENTO 2002 3.5L,
SORENTO 2006 3.3L, H-100 2.4L
MOTOR A GASOLINA (2003 >)
600076



CLAVE: M80810
NUM. PARTE: 438081
MARCHA VALEO 0.85KW 12V NISSAN APRIO 1.6L
RENAULT KANGOO 3 OREJAS CON CUERDA
8 DIENTES CW

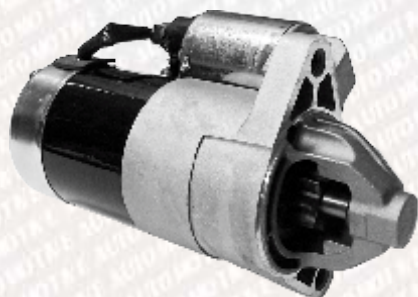

CLAVE: M46010
NUM. PARTE: TM000A246
MARCHA VALEO NISSAN SENTRA



Marchas Sistema Valeo

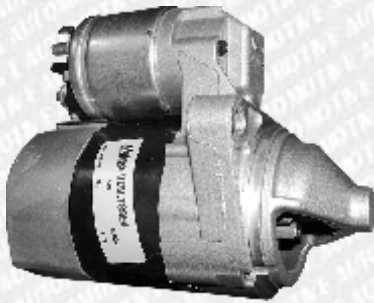

CLAVE: M81374
NUM. PARTE: 438137
MARCHA VALEO 0.75KW 12V
NISSAN ALMERA 1.5L (00-01) 1.8L (00-..)
8 DIENTES CW
LESTER 31206



CLAVE: M81564
NUM. PARTE: 438156
MARCHA VALEO 0.7KW 12V
NISSAN MICRA 1.1L, 1.3/1.4L (01-..)
8 DIENTES CW
LESTER 33080



CLAVE: M37345
NUM. PARTE: D7E34SP
MARCHA VALEO FORD COURIER 1.6L 99=>;
ECOSPORT 1.6L 2003=>; ESCORT 1.6L 99=>;
FIESTA 1.6L 99=>; KA 1.6L 99=>. 12V 0.70KW
CON AIRE ACONDICIONADO
9DIENTES 3 OREJAS
CON CUERDA M07341 438180 D7E43SPM
459011 3565-11000-AA 3565-11000-BA



CLAVE: M10122
NUM. PARTE: FS10B1
MARCHA VALEO
FORD COURIER,
FIESTA,
ESCORT,
KA,
IKON,
COURIER,
ECOSPORT 1.6L MOTOR ZETEC 0.70 kW 12 Vcc
555570, 555544 D7E33/E37

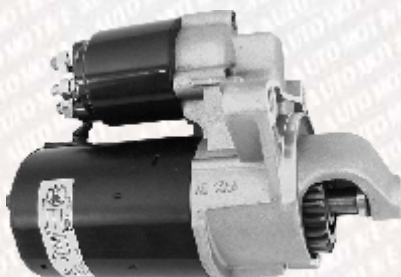

CLAVE: M58940
NUM. PARTE: 455894
MARCHA VALEO
FORD ESCORT 21 DTS. 95-99
FIESTA 95-02, KA 1.3L 96-08



Marchas Sistema Valeo

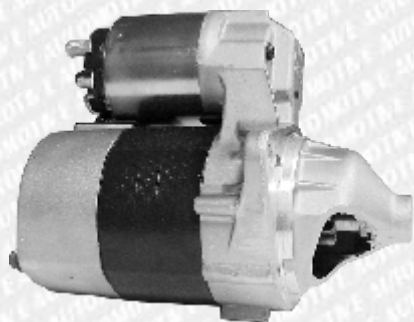

CLAVE: M90166
NUM. PARTE: BD7E17SP
MARCHA VALEO G.M. CORSA 94 ==>;
CHEVY 1.4L, 1.6L, 1.6L 16V 94-2003;
CHEVY PICK UP 1.6L, 1.6L 16V 94 => ;
CHEVY SEDAN 1.6L, 1.6L 16V 94=>;
CHEVY WAGON 1.6L, 1.6L 16V 1996=>.
12V 0.90 KW 438126 93264950



CLAVE: M81839
NUM. PARTE: 438183
MARCHA VALEO CHEVROLET
ASTRA F 1.4L 16V 91-01;
ASTRA 1.6L, 2.0L 16V 91-01;
ASTRA CLASSIC 1.4L, 1.6L 16V 98-02;
ASTRA G 1.4, 1.6L 16V 98-05;
CORSA 1.4L 16V 06 =>;
MERIVA 1.6L 16V 03-04;
TIGRA 1.4L 16V 94-01;
VECTRA 1.4L 88-92, 1.6L 95-99;
VECTRA 1.6L 16V 99-03, 04-05;
ZAFIRA 1.6L 16V 03-05;
ZAFIRA 1.8L 16V 05=>.
458228 9000756 DRS3554 184727

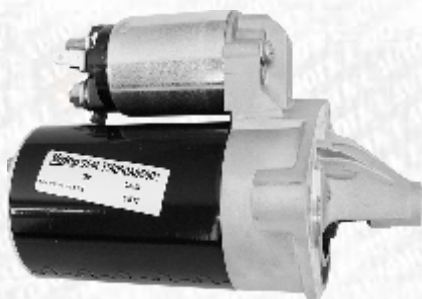

CLAVE: M81986
NUM. PARTE: 438198
MARCHA VALEO CHEVROLET
MATIZ 0.8L 2005=> ;
SPARK 0.8L 2005 =>;
DAEWOO MATIZ 0.8L 98 =>, 1.0L 03-05;
SUZUKI WAGON 98-00



CLAVE: M80925
NUM. PARTE: 438092
MARCHA VALEO PEUGEOT
206 2.0L 16V 99-05;
307 2.0L 16V 01-05;
406 1.8L 16V, 1.8L GPI 16V 00-04; 2.0L 16V 99-04;
407 1.8L 16V 04-05, 2.0L 16V 04-05, 2.2L 16V 04-05;
455961 8080109 M000T82081

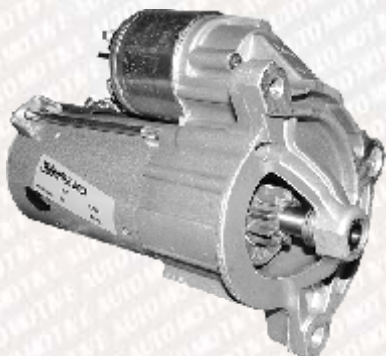

CLAVE: M26236
NUM. PARTE: 432623
MARCHA VALEO 1.2KW 12V PEUGEOT
PARTNER 206 1.6L 16V
9 DIENTES CW
LESTER 30737, 30739, 31197, 33106



Marchas Sistema Valeo

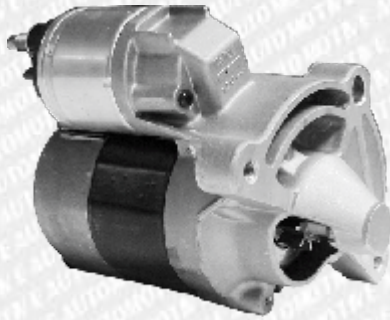

CLAVE: M81298
NUM. PARTE: 438129
MARCHA VALEO PEUGEOT 206 1.6L 16V 2000=>.
12V 0.80KW D7E23 5802M9 5208P8



CLAVE: M81973
NUM. PARTE: 438197
MARCHA VALEO 1.4KW 12V
PEUGEOT 307/407 16V 2/2.2L



CLAVE: M59826
NUM. PARTE: 455982
MARCHA VALEO
PMGR 12V, 1.4kW
CITROEN 02-11
PEUGEOT 307 438133
LESTER 32570N
11 DIENTES



CLAVE: M59592
NUM. PARTE: 455959
MARCHA VALEO RENAULT
TRAFFIC 1.9DCI 01-06;
438090D7R44C 7711134792

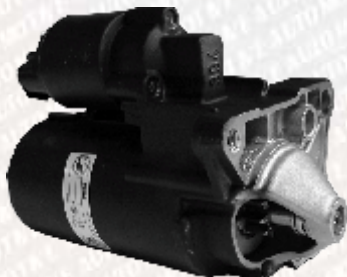

CLAVE: M82744
NUM. PARTE: 458274
MARCHA VALEO 0.9KW 12V RENAULT SPORT,
CLIO II 2L (00-04) III 2L (06-..)
LAGUNA 1.8L (98-01) 2L (99-01) II 1.8L (01-07) II 2L (02-07)
GRAND TOUR II 1.8L (01-05)
MEGANE I 1.8L (01-02) II 2.1L TURBO (04-..)
SCENIC I 2L (00-03) II 2L (04-..) TRAFIC II BUS 2L (06-..)
9 DIENTES



Marchas Sistema Valeo



CLAVE: M30610
NUM. PARTE: 438110
MARCHA VALEO 0.85KW 12V
RENAULT CLIO/KANGOO 1.6L 16V (00-..)
NISSAN PLATINA 1.6L
8 DIENTES CW
8200049826, D7E19, TS10E4

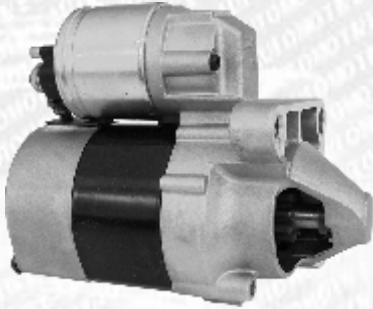

CLAVE: M55676
NUM. PARTE: 555567
MARCHA VALEO RENAULT
MEGANE-SCENIC 1.6 16V
438128



CLAVE: M01765
NUM. PARTE: D7ES6SP
MARCHA VALEO VW POLO,
LUPO CROSSFOX 1.0L 16V
438179SP 555569



CLAVE: M80777
NUM. PARTE: 438077
MARCHA VALEO
VW TRANSPORTER F70 90-96 12V
11 DIENTES



CLAVE: M81712
NUM. PARTE: 438171
MARCHA VALEO 1.1KW 12V SEAT, PASSAT,
GOLF V, AUDI A3, 1.8TFSI, 2.0TFSI, 2.0FSI (05-..)
10 DIENTES CCW
02Z911023G



Marchas Sistema Valeo



CLAVE: M58177

NUM. PARTE: 558175

MARCHA VALEO

AUDI A3 2.0 FSI 03-08,

A3 1.9 TDI 03-10,

A3 2.0 TDI 03-12,

TT 1.8T 05-06,

TT 1.8T QUATTRO 05-06,

SEAT ALTEA 1.9 TDI 04-09,

ALTEA 2.0 TDI 04-09,

CORDOBA 1.4 TDI 05-09, 1.9 TDI 02-09, 2.0 LT 02-09,

IBIZA 2.0L 02-09,

IBIZA 1.4 TDI 02-09,

SEAT LEON 1.9 TDI 05-07, 2.0 FSI 05-10,

TOLEDO 1.9,2.0 TDI 04-09, 2.0 FSI 04-09, 2.0 FSI 04-09,

GOLF A4 1.9 TDI 00-05, 1.9 TDI 4 MOTION 00-05,

GOLF V 1.9 TDI 03-08, 2.0 FSI 04-08, 2.0 TDI 03-08,

JETTA III 2.0 FSI 05-10, 1.9 TDI 05-10, 2.0 TDI 05-10,

PASSAT 1.9 TDI 05-08,

POLO 1.4 TDI 01-09,

TOURAN 2.0 FSI 03-05, 1.9 TDI 04-10,

EUROVAN 03-09 **M81754** 438175

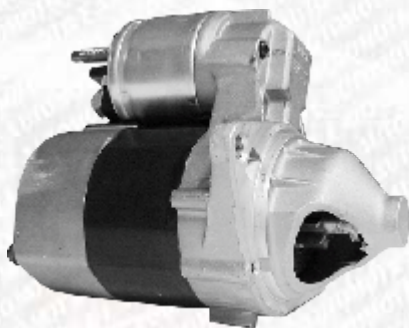

CLAVE: M81855

NUM. PARTE: 438185

MARCHA VALEO FIAT PALIO 1.8L 2003=>;

STILO 1.8L 2003=>; ASTRA 1.8L 99=>;

MERIVA 1.8L 2002=>; CORSA 1.8L 2002=>.

12V 0.90 KW BD7E44 9609313280

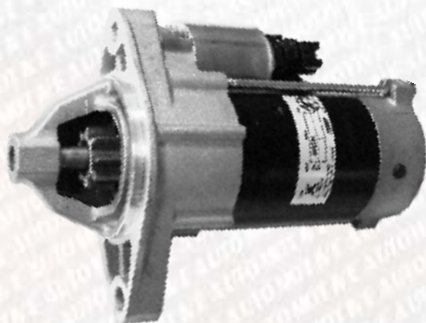

CLAVE: M83207

NUM. PARTE: 458320

MARCHA VALEO 1.0 KW 12V

TOYOTA YARIS 1.3 WTI 16V (05)

9 DIENTES



CLAVE. M62446

NUM. PARTE: 432644

MARCHA VALEO MERCEDES BENZ

CLASE C (W202) C250 TURBO D 93-00;

CLASE C T-MODEL (S203) 01-07;

CLK (C209) 05-09;

CLASE E 97-99; VITO AUTOBUS 96-03;

SPRINTER 2-T AUTOBUS 00-06. 12V

11 DIENTES



Marchas Sistema Valeo



CLAVE: M30914
NUM. PARTE: 2-3091-VA
MARCHA SISTEMA VALEO 1.1KW 12V PMGR AUDI A3,
SEAT IBIZA, ALTEA, CORDOBA, LEON, GOLF,
JETTA EUROPA
10 DIENTES CCW
LESTER 32735 0001120408
VALEO 438173, D6GS13



CLAVE: M81796
NUM. PARTE: 438179
MARCHA IMPORTACION TIPO VALEO
V.W. POLO, LUPO CROOSFOX 1.0L 16V
438179SP 555569



CLAVE: M30800
NUM. PARTE: 33080N
MARCHA TIPO VALEO
NISSAN MICRA 1.4i 16V 0.7KW 12V
8 DIENTES 438156



CLAVE: M43813
NUM. PARTE: 438197
MARCHA IMPORTACION TIPO VALEO
PEUGEOT 307, 407 2.0L 16V; 2.2L 16V 1.4KW 12V.



CLAVE: M43269
NUM. PARTE: 30737N
MARCHA IMPORTACION SISTEMA VALEO
PEUGEOT PARTNER 206 1.6 16v, 1.3KW 12V
9 DIENTES 2-2775-VA 432623



Marchas Sistema Valeo

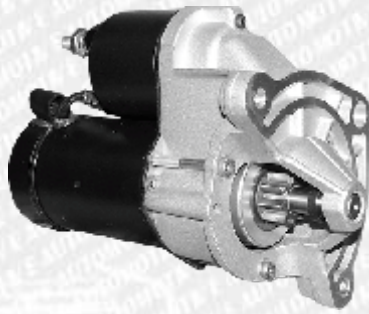

CLAVE: M30737
NUM. PARTE: 30739N
MARCHA SISTEMA VALEO PMGR 1.2KW 12V
PEUGEOT 00-06. CITROEN 88-2010.
LESTER 30737
9 DIENTES

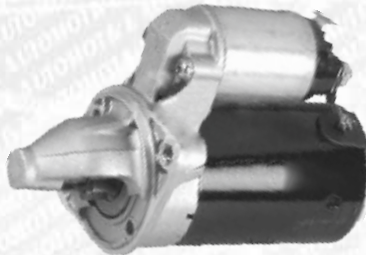

CLAVE: M28055
NUM. PARTE: 36100-22805
MARCHA SISTEMA VALEO PMDD 0.9KW 12V
HYUNDAI ACCENT L4 1.6L (02-08),
DODGE VERNA KIA RIO L4 1.6L (06-08)
8 DIENTES CW
LESTER 17827
VALEO TM00A37210, 2-2260-VA

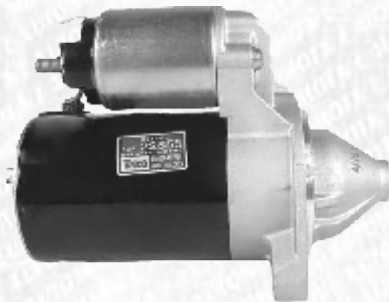

CLAVE: M28553
NUM. PARTE: 36100-22855
MARCHA SISTEMA VALEO PMDD 0.9KW 12V
HYUNDAI ACCENT 1.5L (02) 1.6L (02-09)
KIA RIO 1.6L (06-08)
8 DIENTES CW
LESTER 17826
VALEO TM000A27601, 2-2259-VA



CLAVE: M38103
NUM. PARTE: TM000A37001SP
MARCHA SISTEMA VALEO HYUNDAI ATOS
438101 32453

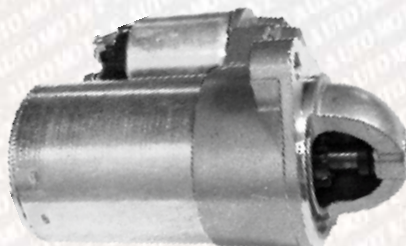

CLAVE: M73850
NUM. PARTE: 96467385
MARCHA NUEVA SISTEMA VALEO PONTIAC
MATIZ 2004=> 12V 1.2KW HSP-017
8 DIENTES 2 OREJAS C/ROSCA



Marchas Sistema Valeo



CLAVE: M81800
NUM. PARTE: 438180
MARCHA SISTEMA VALEO 12V FORD COURIER,
ECOSPORT, FIESTA, NEW FIESTA KA, 1.0/1.6L
9 DIENTES
4381-53, -80, -81 494-813
FORD 3565-11000-AA, -BA, -CA



CLAVE: M00118
NUM. PARTE: 21 K3 0152LC
MARCHA IMPORTACION SISTEMA VALEO
PEUGEOT 206 1.6L 16V 2000=> 12V 0.80KW
D7E23 438129 ES-PEUGEOT-011
555568 M55689

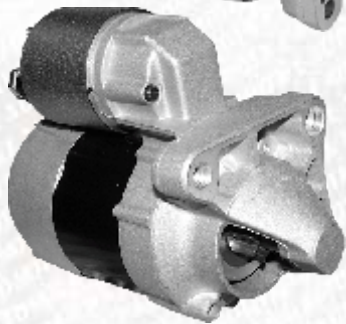

CLAVE: M09128
NUM. PARTE: 40-0912
MARCHA SISTEMA VALEO RENAULT CLIO1.6L 16V 2000=>;
KANGOO 1.6L 16V 2000=>; NISSAN PLATINA 1.6L. 12V
0.85KW 8200049826
TS10E4SP
438110



CLAVE: M20811
NUM. PARTE: 36100-35900
MARCHA MANDO- VALEO PMGR DODGE HYUNDAI H100
GASOLINA 12V 1.21KW
8 DIENTES CW
LESTER 17810N
2-2678-MI

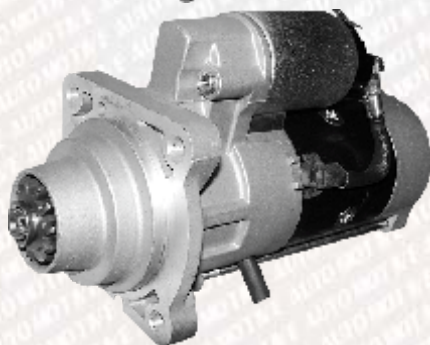

CLAVE: M23063
NUM. PARTE: 2-2306-MD
MARCHA MOTOR MANDO PLGR BOBCAT 2.7KW 12V
11 DIENTES CW
LESTER 18486
6676957, 6685190; TM000A28901

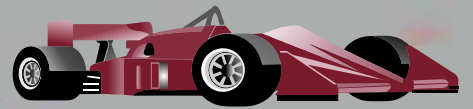

ANIVERSARIO
Tres Décadas de experiencia
nos Respaldan
nos Respaldan
Tres Décadas de experiencia
nos Respaldan

**Buscamos Vendedores para Toda la República Mexicana.
Mayoristas de Autopartes Eléctricas y Accesorios
Somos Distribuidores de las mejores MARCAS**

Av. San Isidro Téopatl #186 Col. Ampliación Petrolera
C. P. 02470 México D.F.
Tels.: 6362-8383 6362-8110
6362-3749 6362-7846
Fax: 5352-3645
Lada sin Costo: 01 800 202 1207

**AUTOPARTES ELÉCTRICAS
AUTOMOTIVE**



www.automotive.com.mx

AUTOPARTES ELÉCTRICAS ***AUTOMOTIVE***

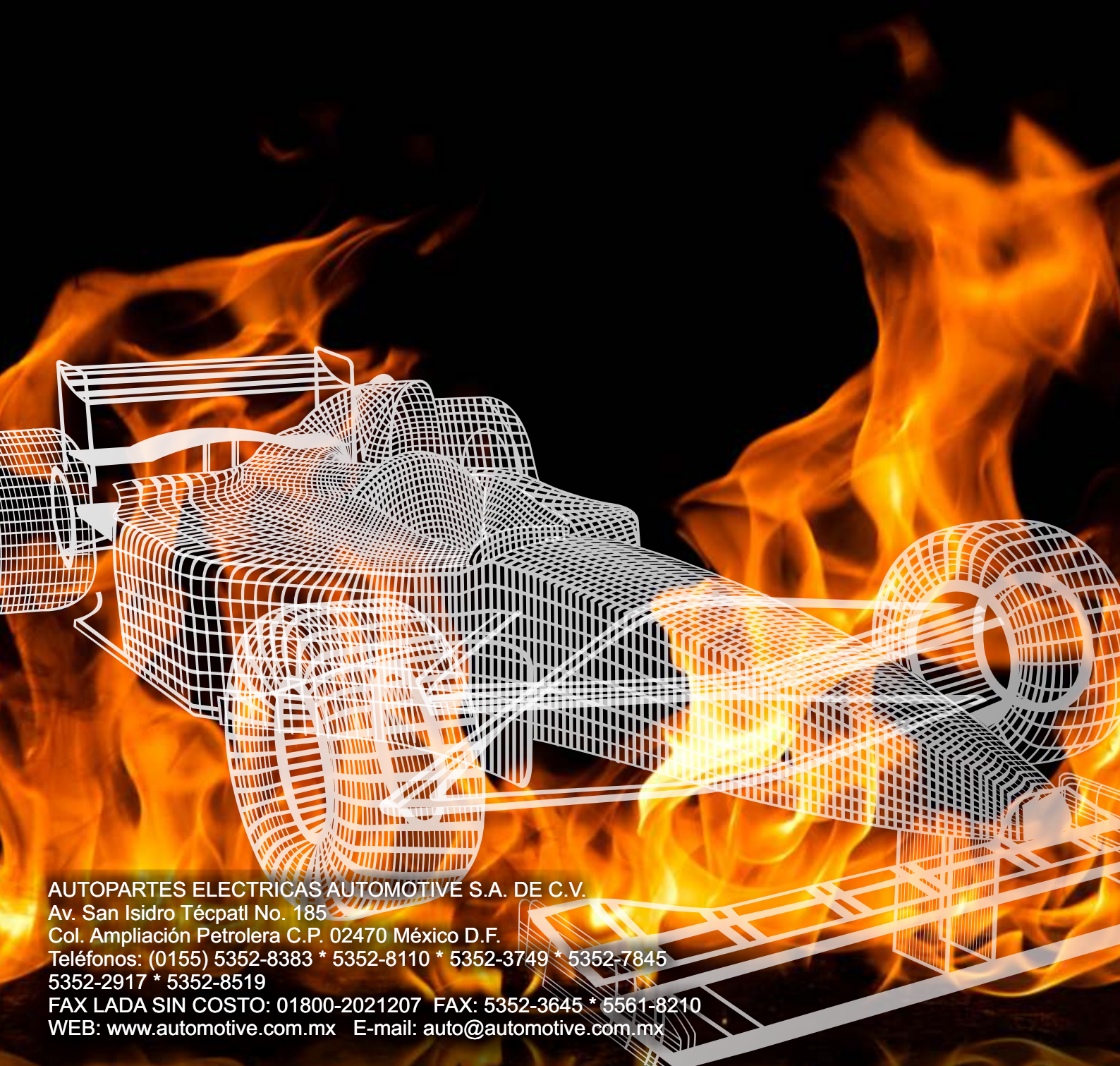
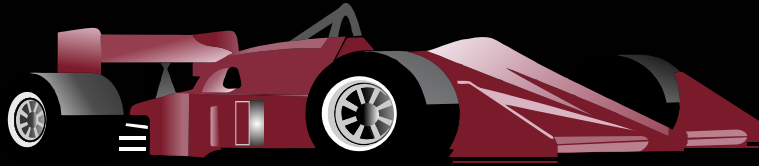

AUTOPARTES ELECTRICAS AUTOMOTIVE S.A. DE C.V.
Av. San Isidro Técpatl No. 185
Col. Ampliación Petrolera C.P. 02470 México D.F.
Teléfonos: (0155) 5352-8383 * 5352-8110 * 5352-3749 * 5352-7845
5352-2917 * 5352-8519
FAX LADA SIN COSTO: 01800-2021207 FAX: 5352-3645 * 5561-8210
WEB: www.automotive.com.mx E-mail: auto@automotive.com.mx